

INSTRUCTION MANUAL

GENERAL-PURPOSE INVERTER



THANK YOU VERY MUCH FOR YOUR PURCHASE
OF ADLEE INVERTER AS SERIES.
PLEASE READ THIS INSTRUCTION MANUAL
BEFORE INSTALLATION OF THE INVERTER.

PREFACE

This general-purpose inverter made by ADLEE Powertronic., Ltd. Read this instruction manual thoroughly before operation.

This manual will be helpful in the installation, parameter setting, troubleshooting, and daily maintenance of the AC motor drives. To guarantee safe operation of the equipment, read the following safety guidelines before connecting power to the AC drives. Keep this operating manual handy and distribute to all users for reference.

A. General Precaution

1. There are some covers and shields on this inverter.
Make sure all covers and shields are replaced before operating this product.
2. This manual may be modified when necessary because of improvement of the product or changes in specification.
3. Contact your ADLEE representative to order a copy of this manual, if your manual has been damaged or lost.
4. ADLEE is not responsible for any modification of the product made by the user, since that will void your guarantee.

B. Safety symbols

Symbols which may appear on the manual

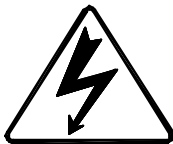

WARNING

Indicates a potentially hazardous situation which, if not avoided, could result in death or serious injury to personnel.



CAUTION

Indicates a potentially hazardous situation which, if not avoided, may result in minor or moderate injury to personnel and damage to equipment.

RECEIVING

CAUTION

- * Do not install or operate the driver which is damaged or has missing parts.
Failure to observe this caution may result in personal injury or equipment damage.
-

INSTALLATION



CAUTION

- * Lift the cabinet by the base. When moving the unit, never lift by the front cover.
Otherwise, the main unit may be dropped causing damage to the unit.
 - * Mount the driver on nonflammable material. (i.e. metal)
Failure to observe this caution can result a fire.
 - * When mounting units in an enclosure, install a fan or other cooling device to keep the intake air temperature below 45 °C.
Overheating may cause a fire or damage to the unit.
-

INSTALLATION

WARNING

- * Only commence wiring after verifying that the power supply is turned OFF.
Failure to observe this warning can result in an electrical shock or a fire.
- * Wiring should be performed only by qualified personnel.
Failure to observe this warning can result in an electrical shock or a fire.
- * Make sure to ground the ground terminal.
Ground resistance : 100 Ohm or less.
Failure to observe this warning can result in an electrical shock or a fire.

CAUTION

- * Verify that the driver rated voltage coincides with the AC power supply voltage.
Failure to observe this caution can result in personal injury or a fire.
- * Do not perform a withstand voltage test of the driver.
It may cause semi-conductor elements to be damaged.
- * To connect a braking resistor, follow in APPENDIX A.
Improper connection may cause the unit damaged or a fire.
- * Tighten terminal screws.
Failure to observe this caution can result a fire.
- * Never connect the AC main circuit power supply to output terminals U, V and W.
The inverter will be damaged and invalidate the guarantee.

OPERATION



WARNING

- * Only turn ON the input power supply after replacing the front cover.
Do not remove the cover while current is flowing.
Failure to observe this warning can result in an electrical shock.



CAUTION

- * Since it is easy to change. operation speed from low to high speed, verify the safe working range of the motor and machine before operation.
Failure to observe this caution can result in personal injury and machine damage.
- * Do not change signals during operation.
The machine or the inverter may be damaged.
- * All the constants of the inverter have been preset at the factory.
Do not change the settings unnecessary.

MAINTENANCE AND INSPECTION

WARNING

- * Never touch high-voltage terminals in the driver.
Failure to observe this warning can result in an electrical shock.
- * Replace all protective covers before powering up the inverter.
To remove the cover, make sure to shut OFF the molded-case circuit breaker.
Failure to observe this warning can result in an electrical shock.
- * Perform maintenance or inspection only after verifying that the CHARGE LED goes OFF, after the main circuit power supply is turned OFF.
The capacitors are still charged and can be dangerous.
- * Only authorized personnel should be permitted to perform maintenance, inspections or parts replacement.
Failure to observe this warning can result in an electrical shock.

CAUTION

- * The control PC board employs CMOS ICs. Do not touch the CMOS elements by hand.
They are easily damaged by static electricity.
- * Do not connect or disconnect wires or connectors while power is applied to the circuit.
Failure to observe this caution can result in personal injury.

OTHERS



WARNING

- * Never modify the product.
Failure to observe this warning can result in an electrical shock or personal injury and will invalidate the guarantee.

CONTENTS

1. RECEIVING	1
2. SPECIFICATIONS	2
3. DIMENSION DRAWINGS	4
4. INSTALLATION	7
5. DESCRIPTION OF TERMINALS	9
6. DIGITAL OPERATION PANEL	15
7. FUNCTIONS DESCRIPTION	16
8. DISPLAY ERROR CODES	44
9. HARDWARE PROTECTIVE FUNCTIONS	47
10. PRECAUTIONS	48
11. TROUBLESHOOTING	49
12. APPLICATION	50
13. INVERTER SELECTION	54
14. APPENDIX	56
A. Optional braking resistor	56
B. Terminal wiring diagram	57
C. Remote operator	59
D. Version	60

1. RECEIVING

This AS series AC drive has gone through rigorous quality control tests at the factory before shipment. After receiving the AC drive, please check for the following :

- (1) No damage is found on each product after shipping.
- (2) The product is as ordered (check the nameplate, voltage and frequency).
- (3) A set of inverter unit and instruction manual is contained in the package.

For any irregularity, contact the sales shop where you purchased immediately.

- (4) Description of name plate

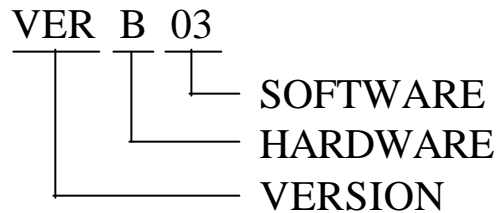
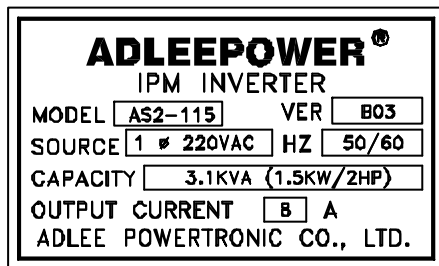

MODEL : AS 2 - 115 R

AS series

Voltage class :

1 : 110V

2 : 220V

4 : 380/440V

R : REMOTE CONTROL SERIES

H : HIGH SPEED SERIES

T : TIMING AND SPEED CONTROL SERIES

RP : REMOTE CONTROL AND PID CONTROL SERIES

RT : REMOTE CONTROL AND SPEEDS WITH TIMING CONTROL SERIES

Max Applicable motor(4 pole)

Single Phase :

104 : 0.4KW 107 : 0.75KW 115 : 1.5KW

122 : 2.2KW 137 : 3.7KW





3 Phase :

304 : 0.4KW 307 : 0.75KW 315 : 1.5KW





322 : 2.2KW 337 : 3.7KW

2. SPECIFICATIONS

(1) Single phase input port

Model	AS1		AS2				
Voltage	1 110VAC \pm 10%		1 220VAC \pm 10%				
Model No	AS1-104	AS1-107	AS2-104	AS2-107	AS2-115	AS2-122	AS2-137
Input Frequency	50HZ ~ 60HZ \pm 10%						
Output Voltage	3 220VAC						
Output Frequency	0.5 ~ 400HZ / 0.5 ~ 2000HZ (High frequency)						
Output Rated current (A)	3 A	5 A	3 A	5 A	8 A	11 A	17 A
Capacity (KVA)	1.1 KVA	1.9 KVA	1.1 KVA	1.9 KVA	3.1 KVA	4.2 KVA	6.5 KVA
Largest motor KW (4 poles)	0.4KW	0.75KW	0.4KW	0.75KW	1.5KW	2.2KW	3.7KW
Control	Sine wave pulse width modulation						
Braking	Regenerative discharge braking						
Over current Capacity	150% of rated current (1 minute)						
Acceleration time	0.1 ~ 6000 SEC						
Deceleration time	0.1 ~ 6000 SEC						
Frequency setting	Digital	Use keyboard    for setting and confirm by 					
	Analog	By frequency knob					
Display type	LED Digits						
Cooling Method	Self-cooled	Air-cooled	Self-cooled	Self-cooled	Air-cooled	Air-cooled	Air-cooled
Dimension drawing	Fig 1	Fig 2	Fig 1	Fig 1	Fig 2	Fig 2	Fig 3
Weight (NW . KG)	1.2KG	1.3KG	1.2KG	1.3KG	1.3KG	1.4KG	4.0KG

(2) 3 Phase input port

Model	AS2					AS4			
Voltage	3 220VAC \pm 10%					3 380/440VAC \pm 10%			
Model No	AS2-304	AS2-307	AS2-315	AS2-322	AS2-337	AS4-307	AS4-315	AS4-322	AS4-337
Input Frequency	50HZ ~ 60HZ \pm 10%								
Output Voltage	3 220VAC					3 380/440VAC			
Output Frequency	0.5 ~ 400HZ / 0.5 ~ 2000HZ (High frequency)								
Output Rated current (A)	3 A	5 A	8 A	11 A	17 A	2.5 A	4 A	6 A	9 A
Capacity (KVA)	1.1 KVA	1.9 KVA	3.1 KVA	4.2 KVA	6.5 KVA	1.9 KVA	3.1 KVA	4.2 KVA	6.9 KVA
Largest motor KW (4 poles)	0.4 KW	0.75 KW	1.5 KW	2.2 KW	3.7 KW	0.75 KW	1.5 KW	2.2 KW	3.7 KW
Control	Sine wave pulse width modulation								
Braking	Regenerative discharge braking								
Over current Capacity	150% of rated current (1 minute)								
Acceleration time	0.1 ~ 6000 SEC								
Deceleration time	0.1 ~ 6000 SEC								
Frequency setting	Digital	Use keyboard    for setting and confirm by 							
	Analog	By frequency knob							
Display type	LED Digits								
Cooling Method	Self-cooled	Self-cooled	Air-cooled	Air-cooled	Air-cooled	Air-cooled	Air-cooled	Air-cooled	Air-cooled
Dimension drawing	Fig 1	Fig 1	Fig 2	Fig 2	Fig 3	Fig 2	Fig 2	Fig 3	Fig 3
Weight (NW . KG)	1.2 KG	1.3 KG	1.3 KG	1.4 KG	4.0 KG	1.3 KG	1.3 KG	4.0 KG	4.2 KG

3. DIMENSION DRAWINGS

Unit : mm

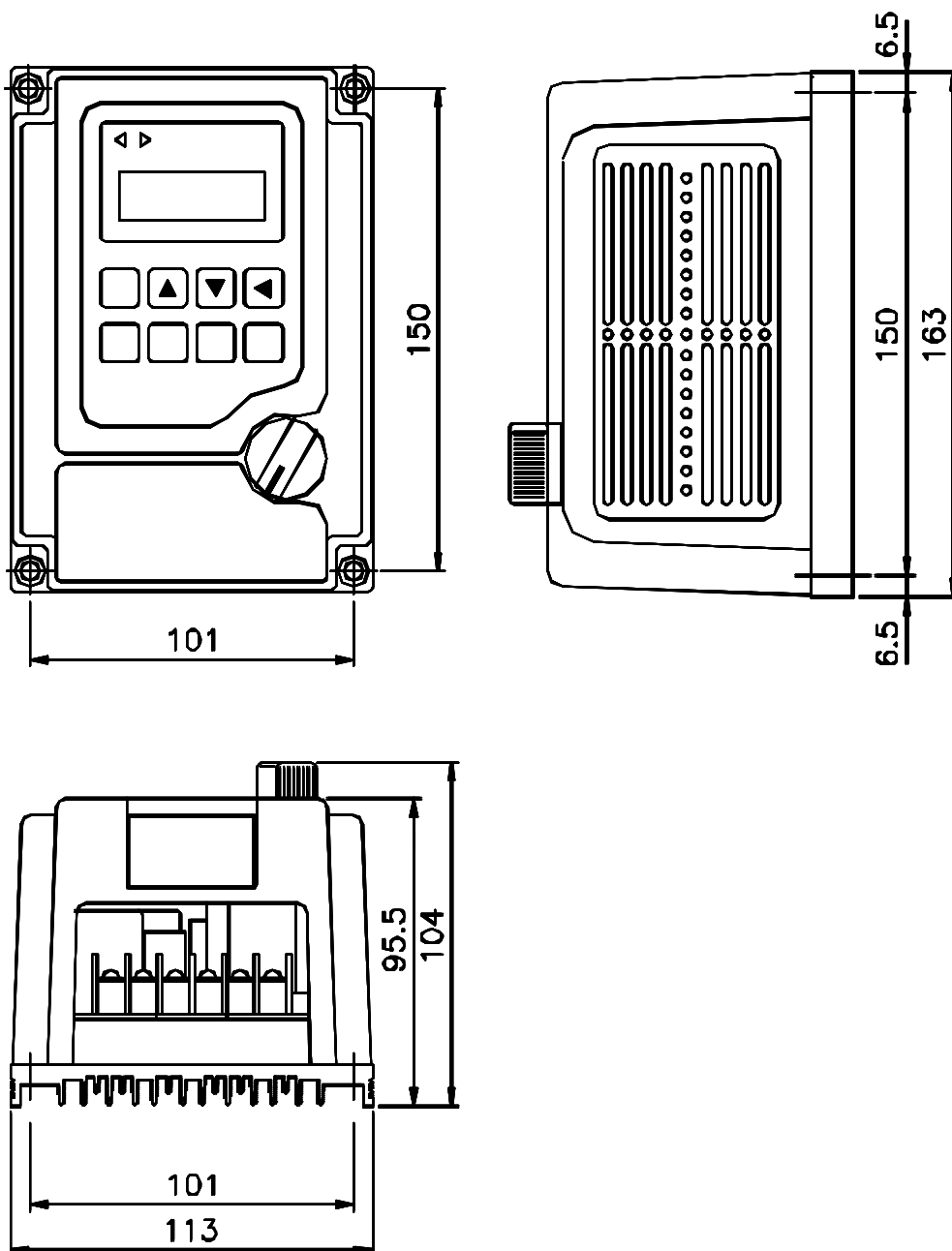

Fig 1

Unit : mm

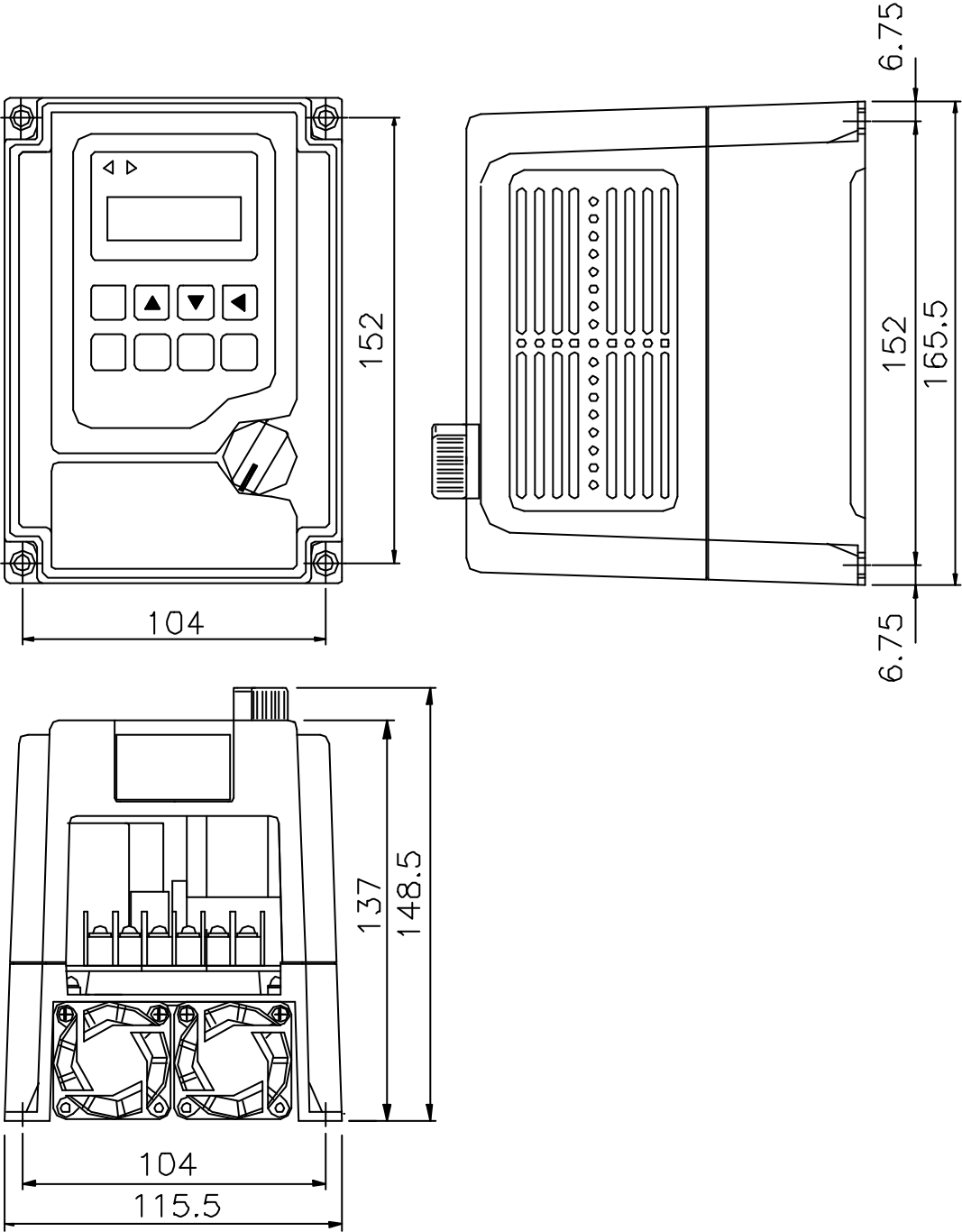

Fig 2

Unit : mm

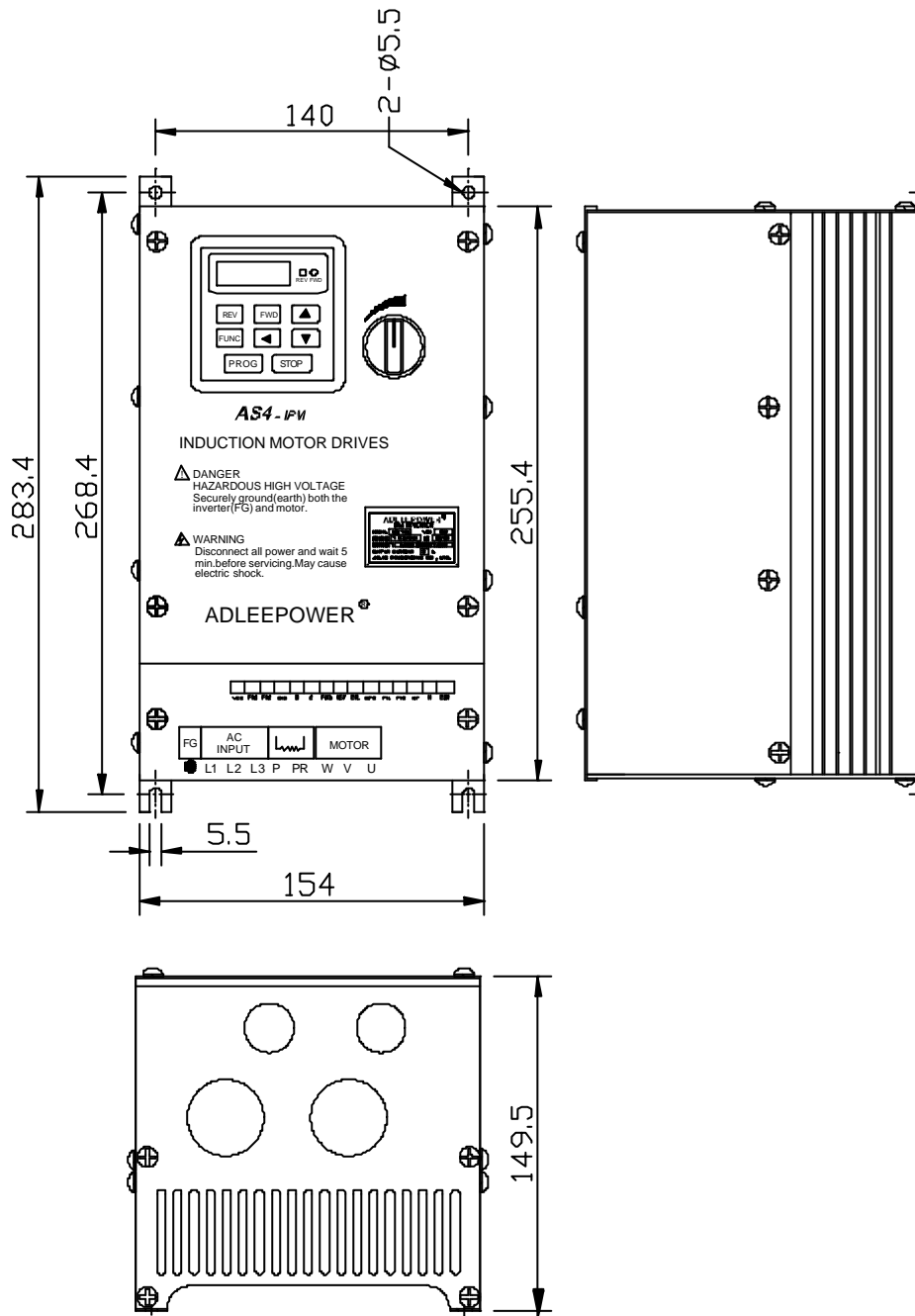

Fig 3

4. INSTALLATION

Inadequate environment around installation site and installation surface can result in damage to the inverter.

Before operating the AS series inverter, please check the following points :

- (1) Avoid high temperature, high humidity, easy-to-dew ambient environment. Don't expose to dust or dirt, corrosive gas, and coolant mist, and direct sunlight. Place the unit in a well-ventilated room.
- (2) Avoid a place subjected to substantial vibration.
- (3) When installing the unit within the cabinet. Please pay attention to ventilation and limit the ambient temperature in between $-10 \sim 45$. ($14 \sim 113$).
- (4) Use a nonflammable material, such a steel sheet on the wall for installation. (The rear side will generate heat)
- (5) Install the unit always vertically with a marginal spacing around.

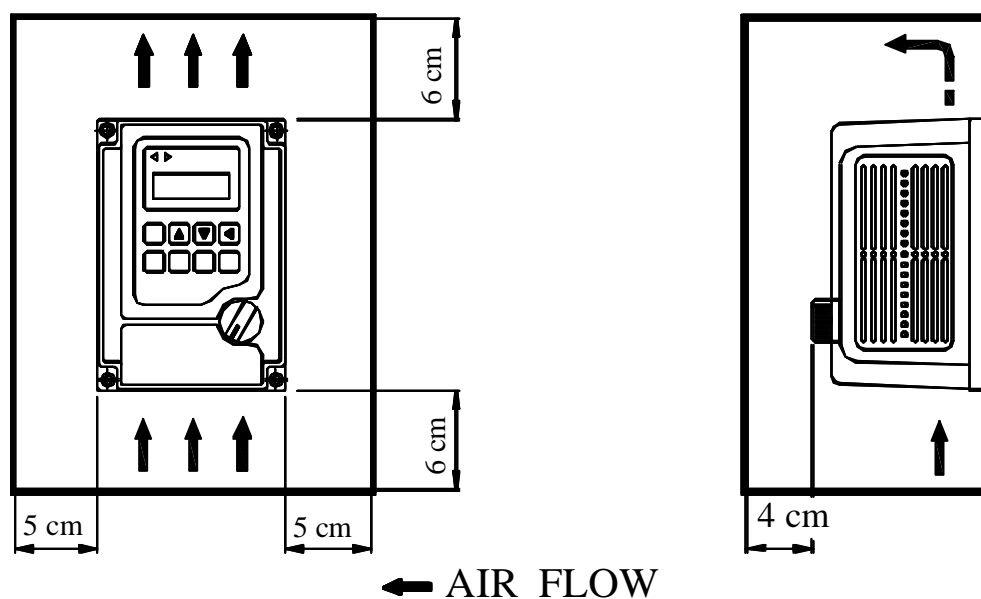

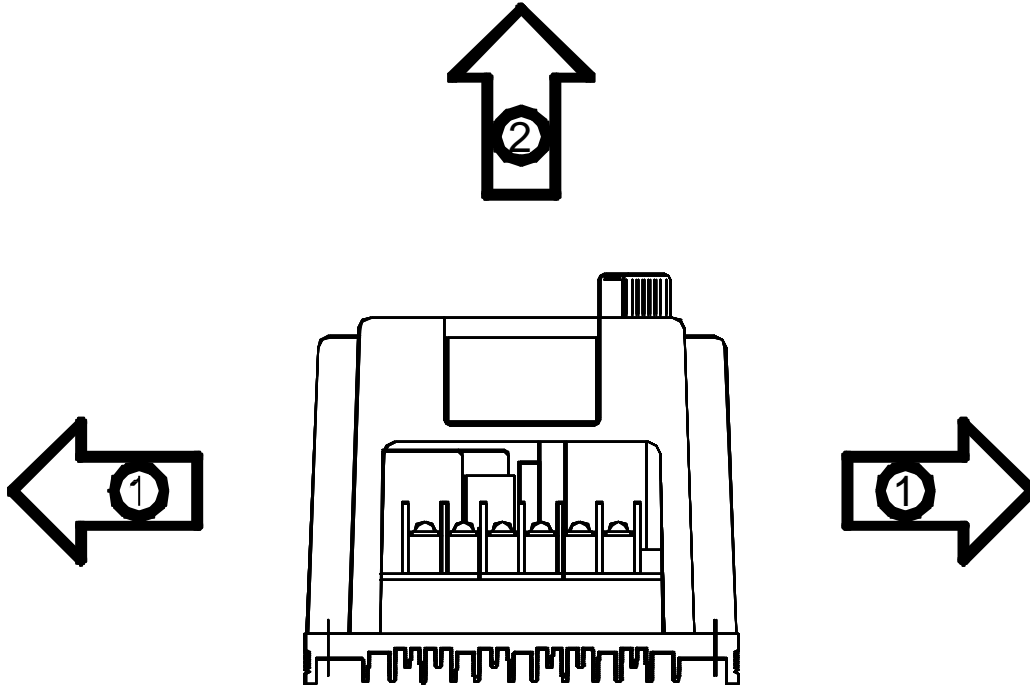
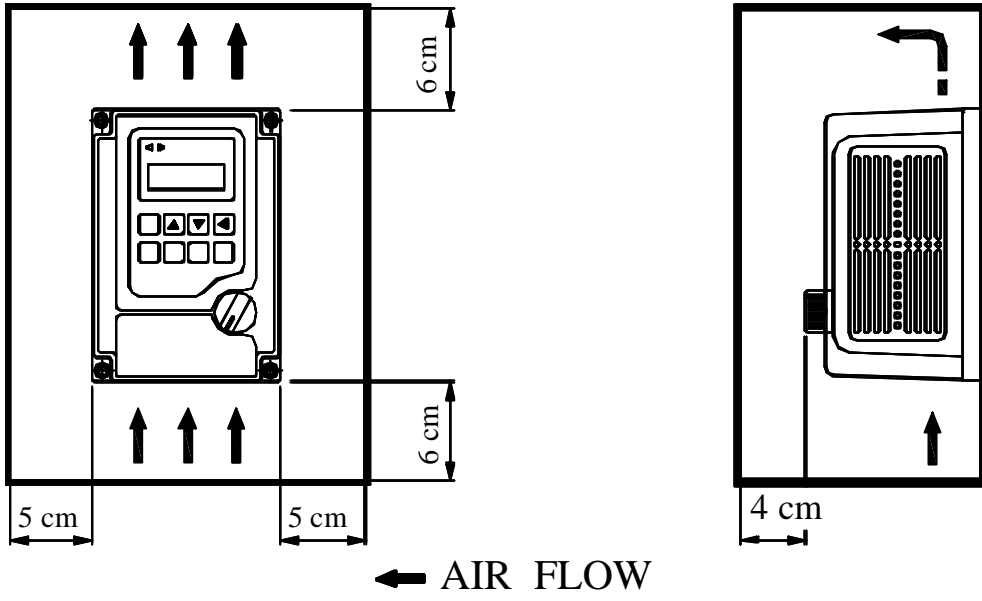

5. DESCRIPTION OF TERMINALS

(1) Main circuit connection diagram

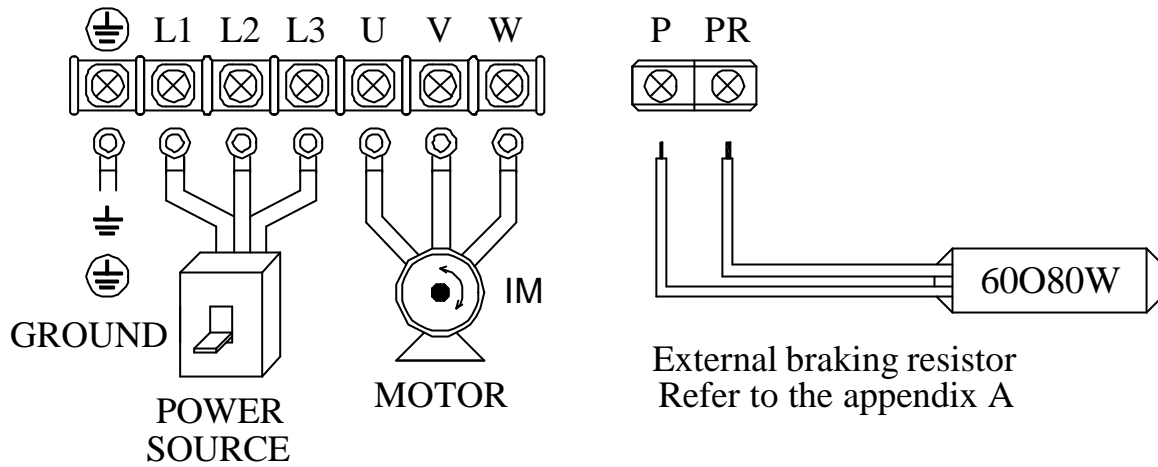

Main circuit terminal			
No.	Symbol	Description	Terminal name
1		Ground	Ground(Earth) Terminal
2	L1	Connect power supply	(L1,L2) Single Phase (L1,L2,L3) 3 Phase
3	L2		
4	L3		
5	U	Inverter output	Terminals connected to motor
6	V		
7	W		
8	P	Dynamic brake	Terminals connected to braking Resistor
9	PR		

(2) Control circuit terminal

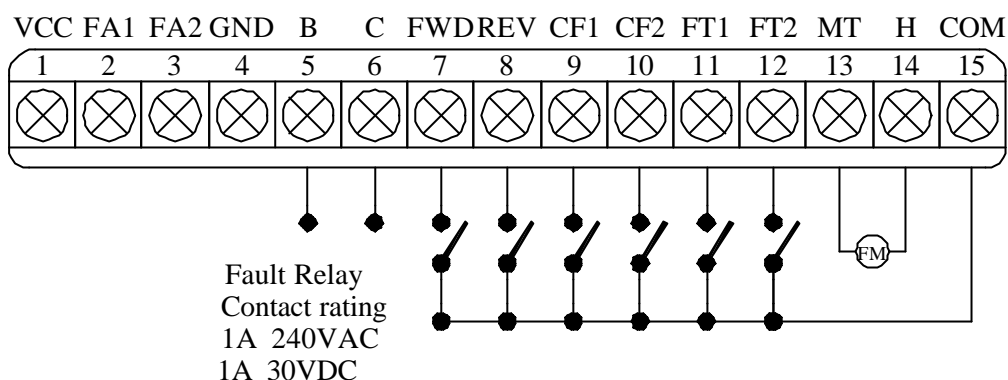



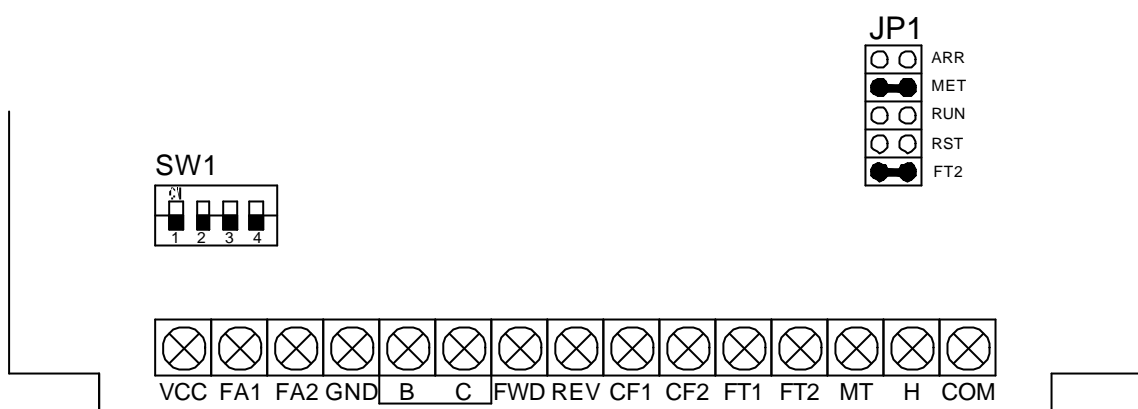

No	Symbol	Multi function analog terminal	
1	VCC	Analog source	Power source +5V of analog terminals
2	FA1	Free analog terminal 1	See CD44 & 3-1 SW1
3	FA2	Free analog terminal 2	See CD45 & 3-1 SW1
4	GND	Analog common terminal	Common terminal of free analog terminals

Control circuit terminal																		
No	Symbol	Terminal name	Description															
5	B	Alarm output B	Fault alarm contact (normal close)															
6	C	Alarm output C	Fault alarm contact (common)															
7	FWD	Forward operation	Forward operation / stop terminal															
8	REV	Reverse operation	Reverse operation / stop terminal															
9	CF1	Multistage speed terminal	<table border="1"> <thead> <tr> <th>CF1</th> <th>CF2</th> <th>SPEED</th> </tr> </thead> <tbody> <tr> <td>OFF</td> <td>OFF</td> <td>SPEED - 1</td> </tr> <tr> <td>ON</td> <td>OFF</td> <td>SPEED - 2</td> </tr> <tr> <td>OFF</td> <td>ON</td> <td>SPEED - 3</td> </tr> <tr> <td>ON</td> <td>ON</td> <td>SPEED - 4</td> </tr> </tbody> </table>	CF1	CF2	SPEED	OFF	OFF	SPEED - 1	ON	OFF	SPEED - 2	OFF	ON	SPEED - 3	ON	ON	SPEED - 4
CF1	CF2			SPEED														
OFF	OFF	SPEED - 1																
ON	OFF	SPEED - 2																
OFF	ON	SPEED - 3																
ON	ON	SPEED - 4																
10	CF2																	
11	FT1	Multi function terminal 1	See functions description (CD42)															
12	FT2	Multi function terminal 2	See functions description (CD43)															
13	MT	Multi function output terminal (SEE 3-2 JP1)																
14	H	Ref source +10V	Basic source +10V 20mA															
15	COM	Common terminal	Common terminal of control terminals															

(3) Description of Hardware setting

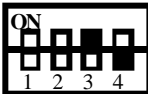
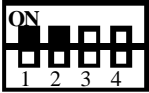
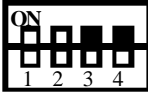
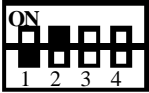

3-1 DIP Switch setting (SW1)

Setting FA1		Setting FA2	
	FA1 : 0 - 10V		FA2 : 0 - 10V
	FA1 : 0 - 5V		FA2 : 0 - 5V
	FA1 : 4 - 20mA		FA2 : 4 - 20mA
	Error setting		Error setting

3-2 Jumper Setup (JP1)

MT : Multi function output terminal selector signal

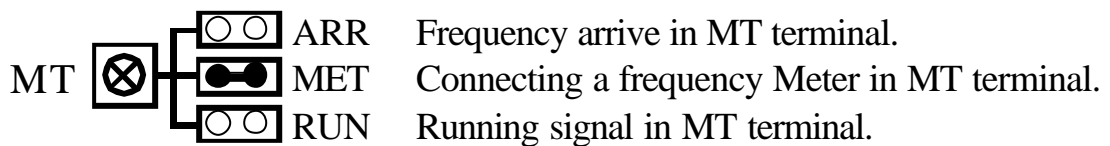

FT2 : Free Terminal 2 function selector



(4) WIRING

4-1 Wiring of main circuit

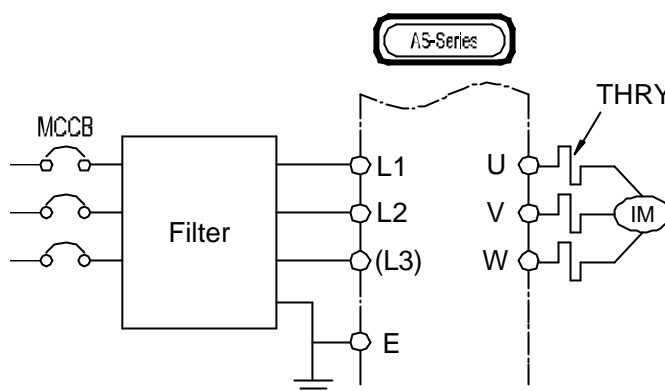

4-2 Wiring equipments

Select the wiring equipment and wiring size, refer to the table below.

1. On the input power side, a molded case circuit breaker (MCCB) to protect inverter primary wiring should be installed.
2. A leakage current breaker threshold of 200mA and above, or of inverter use is recommended.
3. Use of input side magnetic contactor. An input MC can be used to prevent an automatic restart after recovery from an external power loss during remote control operation. However, do not use the MC reduced reliability.
4. In general, magnetic contactors on the output of the inverter, Should not be used for motor control. Starting a motor with the inverter running will cause large surge currents and the inverter overcurrent protector to trigger.

Model	AS1		AS2					AS4			
Model No	04	07	04	07	15	22	37	07	15	22	37
Capacity (KVA)	1.1	1.9	1.1	1.9	3.1	4.2	6.5	1.9	3.1	4.2	6.5
Current (A)	3	5	3	5	8	11	17	2.5	4	6	9
Circuit Breaker (MCCB) (A)	15	15	10	10	15	20	20	10	10	10	15
Electro-Magnetic Contactor (A)	12	12	12	12	12	12	18	12	12	12	12
Thermal relay RC value (A)	4.8	7.6	2.4	3.8	6.8	9	15	1.9	3.4	3.8	6.8

4-3 Surge absorber

In order to prevent malfunction, provide the surge absorber on the coils of the electromagnetic contactors, relays and other devices which are to be used adjacent of the inverter.

4-4 Cable size and length

If the inverter is connected to a distant motor (especially when low frequency is output), motor torque decreases because of voltage drop in the cable. Use sufficiently heavy wire.

Changing the carrier frequency reduce RF1 noise and leakage current. (Refere to the table below)

Distance INVERTER MOTOR	under 25M	under 50M	under 100M	above 100M
AS2 SERIES	under 16KHZ	under 10KHZ	under 5KHZ	under 2.5KHZ

4-5 EMI filter specifications

AS SERIES	FREQUENCY (MHZ)					
	0.15	0.5	1	5	10	30
Typical insertion loss (dB)	11	50	62	65	65	60

4-6 Wiring and cautionary points

A. Main circuit

1. Connect the cables of the power supply side to the U, V and W output terminals for the motor.
2. Don't connect any electromagnetic contactor between the inverter and motor. If it is inevitable, turn on the contactor when both the inverter and motor are both at stand still.
3. Don't put the advance phase capacitor between the inverter and motor.
4. Put MCCB in the input power supply.

B. Control signal circuit

1. Separate the power cables of main circuit etc. from the control cables of the sequence and analog signals by passing the cables through the different ducts.
2. Use twisted pair shielded wire for control signal and connect the shield to earth terminal at on end, COMMON terminal of control board. Leave the other end of shielding open.
3. Avoid common Ground leads between high and low level voltage equipment.

C. Grounding

1. Be sure ground both the inverter and motor.
2. Keep grounded leads as short as possible.
3. Shield cables used to protect low-level signal leads should grounded at one end point.
4. Provide class 3 grounding (100 or less) for a terminal.
5. When grounding several inverters, make connections as shown below, no loop is produced as shown in FIG "a", FIG "b".

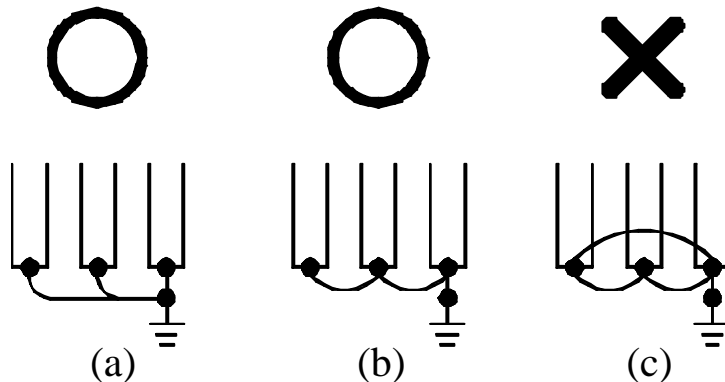

6. DIGITAL OPERATION PANEL

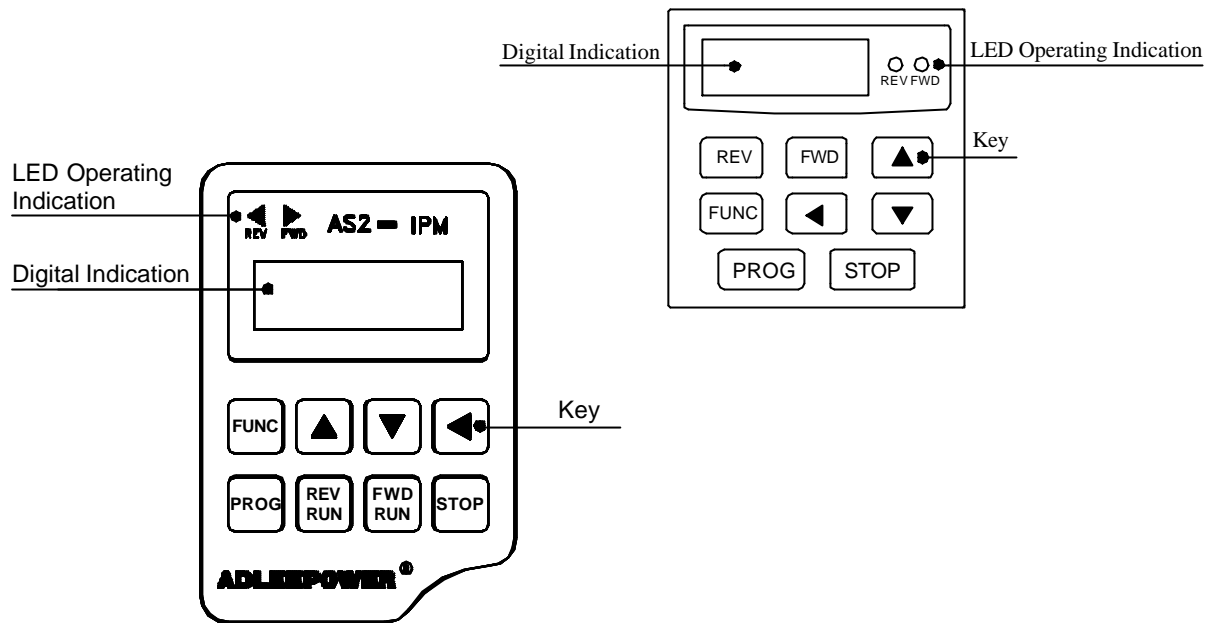

Operation key		Key function	Description
	FWD RUN	Forward run	Commands forward run
	REV RUN	Reverse run	Commands reverse run
	SHIFT	Cursor movement	Select the digit
	DOWN	Down	Decrease the parameter value
	UP	Up	Increase the parameter value
	PROG	Memory storage	Saves the setting vaule
	FUNC	Function	Press once to select function CDxx and press again to change its content
	STOP	Stop	Stop operation / Escape to standby mode

7. FUNCTIONS DESCRIPTION

DISPLAY ORDER	FUNCTION NAME	STANDARD SETTING VALUE
CD00	First speed setting	U : 60HZ
		E : 50(B03) / 0(B04)
CD01	Parameter lock	0
CD02	Acceleration time 1	10 Sec
CD03	Deceleration time 1	10 Sec
CD04	Jogging frequency	5HZ
CD05	Start frequency	0.5HZ
CD06	Jog mode	0
CD07	Frequency meter correspond	U : 120 HZ
		E : 100 HZ
CD08	CW or CCW or CW / CCW	0
CD09	Reserved	0
CD10	Keyboard / Analog signal from terminal	0
CD11	Dynamic brake / Free running	0
CD12	Terminal / Key board command	0
CD13	Reserved	
CD14	Maximum frequency limit	U : 120 HZ
		E : 50 HZ
CD15	Minimum frequency limit	0
CD16	Frequency display Scale	U : 1
		E : 30
CD17	Maximum voltage frequency	U : 60 HZ
		E : 50 HZ

Different initial set value for E : European version and U : US version.
To change version see description of CD52.

CHANGEABLE OF SETTING VALUE	UNIT	USER SETTING	REMARK
0 ~ 400 HZ	0.01 HZ		
0 or 1	----		0 = lock 1 = Unlock
0.1 ~ 6000 Sec	0.1 Sec		
0.1 ~ 6000 Sec	0.1 Sec		
0 ~ 400 HZ	0.01 HZ		
0.5 ~ 30 HZ	0.01 HZ		
0 or 1	----		0 = Normal 1 = Jog
30 ~ 400 HZ	0.01 HZ		
0 ~ 2	----		0 = CW/CCW 1 = CW 2 = CCW
0 or 1	----		0 = Keyboard input 1 = Frequency knob
0 or 1	----		0 = Dynamic brake 1 = Free running
0 or 1	----		0 = Keyboard 1 = Terminal
0.5 ~ 400 HZ	0.01 HZ		
0 ~ 400 HZ	0.01 HZ		
0.01 ~ 500	0.01		Display = Frequency × Scale
25 ~ 400 HZ	0.01 HZ		

DISPLAY ORDER	FUNCTION NAME	STANDARD SETTING VALUE
CD18	V/F pattern setting	0
CD19	DC braking time	1 Sec
CD20	DC braking power	10
CD21	Torque boost	0 %
CD22	Second speed setting	20 (B03) / 0 (B04)
CD23	Third speed setting	30 (B03) / 0 (B04)
CD24	Fourth speed setting	40 (B03) / 0 (B04)
CD25	Acceleration time 2	10 Sec
CD26	Deceleration time 2	10 Sec
CD27	Carrier frequency	16 KHZ
CD28	Output voltage gain	100 %
CD29	Frequency jump 1	0 HZ
CD30	Frequency jump 2	0 HZ
CD31	Frequency jump 3	0 HZ
CD32	Jump range	0.5 HZ
CD33	Frequency reference bias	0
CD34	Frequency reference bias direction	0
CD35	Frequency gain	100.0 %
CD36	The latest error record	NONE
CD37	Errors record 1	NONE

CHANGEABLE OF SETTING VALUE	UNIT	USER SETTING	REMARK
0 ~ 2	----		0 : Constant torque 1 : (Frequency) 2.0 2 : (Frequency) 3.0
0 ~ 25 Sec	0.1 Sec		
0 ~ 250	1.00		
0 ~ 25%	0.1 %		
0 ~ 400 HZ	0.01 HZ		
0 ~ 400 HZ	0.01 HZ		
0 ~ 400 HZ	0.01 HZ		
0.1 ~ 6000 Sec	0.1 Sec		
0.1 ~ 6000 Sec	0.1 Sec		
1KHZ ~ 16KHZ	0.1 KHZ		
50 ~ 100 %	0.1 %		
0 ~ 400 HZ	0.01 HZ		
0 ~ 400 HZ	0.01 HZ		
0 ~ 400 HZ	0.01 HZ		
0.5 ~ 3 HZ	0.01 HZ		
0 ~ 400 HZ	0.01 HZ		
0 or 1	----		0 = Positive 1 = Negative
40 ~ 200 %	0.1 %		

DISPLAY ORDER	FUNCTION NAME	STANDARD SETTING VALUE
CD38	Errors record 2	NONE
CD39	Errors record 3	NONE
CD40	Clear errors record	0
CD41	HZ / RPM Display	0
CD42	FT1 Multi-Function Terminal 1	0
CD43	FT2 Multi-Function Terminal 2	0
CD44	FA1 Free Analog Terminal 1	0
CD45	FA2 Free Analog Terminal 2	0
CD46	Reserved	
CD47	5th speed setting	25 (B03) / 0 (B04)
CD48	6th speed setting	35 (B03) / 0 (B04)
CD49	7th speed setting	45 (B03) / 0 (B04)
CD50	8th speed setting	55 (B03) / 0 (B04)
CD51	Dynamic Braking Energy Limit	100
CD52	Version selector	
CD53	S curve	0
CD54	4 ~ 20mA speed command	0
CD55	Frequency arrive signal range	10 %
CD56	2nd Maximum voltage frequency	60 HZ
CD57	No, of auto restart attempt	0



This function provides different standard setting values for European and USA Version.

CHANGEABLE OF SETTING VALUE	UNIT	USER SETTING	REMARK

0 or 1	----		1 = Clear
0 or 1	----		0 = HZ Display 1 = RPM Display
0 or 1	----		
0 ~ 15	----		RESET SEE 3-2 JP1
0 ~ 15	----		
0 ~ 15	----		
0 ~ 400 HZ	0.01 HZ		
0 ~ 400 HZ	0.01 HZ		
0 ~ 400 HZ	0.01 HZ		
0 ~ 400 HZ	0.01 HZ		
0 ~ 300	1		0 = Auto turning
Eur European Version			
USA US Version			
0 ~ 10			0 = Normal 1~10 = S Surve
0 ~ 3			
0 ~ 100 %	1 %		
25 ~ 400 HZ	0.01 HZ		
0 ~ 10	----		

7-1. Function setting

Before starting test run, check carefully the following points :

- (1) Be sure to connect the power supply to L1, L2, L3 (input terminals) and the motor to U.V.W. (output terminals). (Wrong connections will damage the inverter.)
- (2) Check that the input power supply coincide with input voltage and input phase of the inverter.
- (3) Check the signal lines for correct wiring.
- (4) Be sure to ground an earth terminal for personnel safety.
- (5) Check that other terminals other than earth terminal are not grounded.
- (6) Check that the inverter is mounted on the wall. Also check that non-flammable material.
- (7) For operation start and stop, use    and FWD / REV terminals. Never use input power supply to switch ON/OFF.

Operating

Action : (a) Press   for forward / reverse operation.

function : (a) Press    for function setting and confirm by  .



speed : (a) Using frequency knob for motor speed setting.

(b) Using keyboard   and  for motor speed setting. set CD10 = 0 at first, see Function description

Standby : (a) Press  back to standby mode after trip or function setting mode.

First speed setting
CD00

Setting Range	0 ~ 400 HZ
USA Version	60 HZ
European Version	50 (B03) / 0 (B04)

Press   key for increase or decrease the speed with 1HZ increment step for quick setting.

Press  key to select the digit.

Press  to save the setting value.

Parameter lock
CD01

Setting Range	0 or 1
Factory Setting	0

0 : Lock 1 : Unlock

Function to prevent inadequate setting.

To change the contents CD02 ~ CD56 , set CD01=1 and press  first.

To lock the data set CD01=0 and press  .

Acceleration time 1
CD02

Setting Range	0.1 ~ 6000 Sec
Factory Setting	10 Sec

CD02 value corresponds to the time of acceleration from the minimum frequency to 60HZ.(For 120Hz. setting, the arrival time to 120Hz is double.)

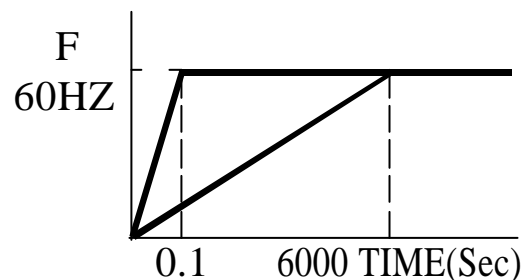

Deceleration time 1
CD03

Setting Range	0.1 ~ 6000 Sec
Factory Setting	10 Sec

CD03 value corresponds to the time of deceleration from 60HZ to the minimum frequency.

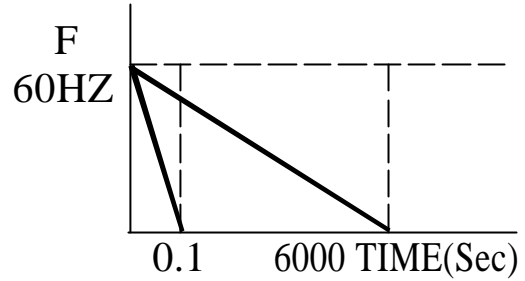

Jogging frequency
CD04

Setting Range	0 ~ 400 HZ
Factory Setting	5 HZ

Use terminal control refer to CD12 and CD42 setting, keyboard control refer to CD06.

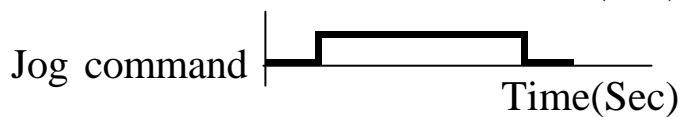
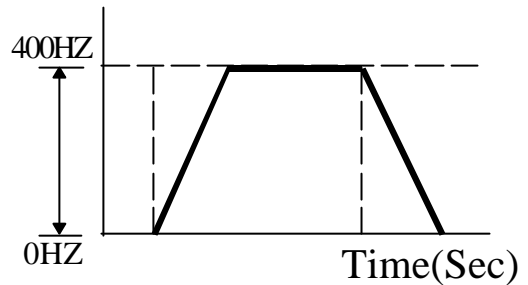

Start frequency
CD05

Setting Range	0.5 ~ 30 HZ
Factory Setting	0.5 HZ

When setting this value, pay attention to the starting current.

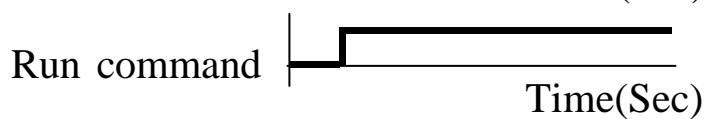
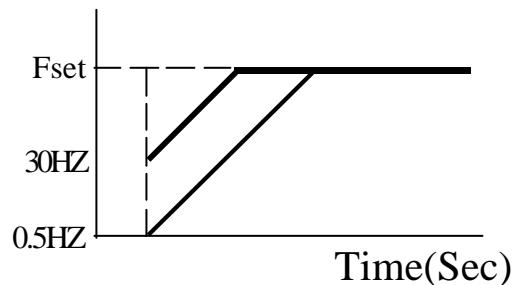

Jog mode
CD06

Setting Range	0 or 1
Factory Setting	0

0 : Normal 1 : Jog Mode

1. Set jogging operation from key panel **FWD RUN** & **REV RUN** .
2. **REV RUN** **FWD RUN** LED blinking in JOG mode.

Frequency meter correspond
CD07

Setting Range	30.00 ~ 400.00 HZ
USA Version	120.00 HZ
European Version	100.00 HZ

The specification of the output meter is 10V(i.e. 1mA) full scale rating and 30~400HZ frequency range.

Set by CD07 the value will be correspond to maximum correspond of output meter.

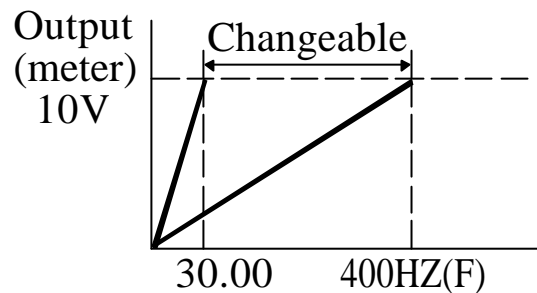

CW or CCW or CW/CCW
CD08



Setting Range	0 ~ 2
Factory Setting	0

- 0 : CW/CCW operation
 1 : CW only
 2 : CCW only



If inadequate operation, the “OPE2“ warning message would be indicated.

Analog / Digital frequency
CD10

Setting Range	0 or 1
Factory Setting	1

0 : Operation frequency change by using  or  key and confirm by  .

1 : Operation frequency change by adjusting the angle of the knob.

Note : Using   key to change motor speed when CD01=1, the “OPE3“ warning message would be indicated.

Dynamic brake / Free running
CD11

Setting Range	0 or 1
Factory Setting	0

0 : Activates dynamic brake function when deceleration. Decelerating time depends on CD3 setting.

1 : Output cut off when accept a stop command.

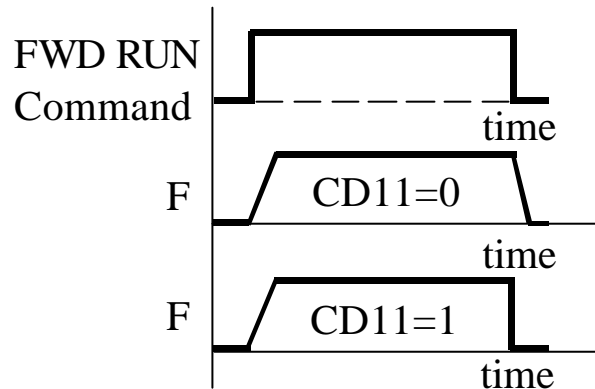

Terminal / Key board command
CD12

Setting Range	0 or 1
USA Version	0
European Version	1

0 : RUN/STOP Command from operation panel.

1 : RUN/STOP Command from control terminal.

Note : If inadequate operation, the “OPE4“ warning message would be indicated.

Maximum frequency limit
CD14

Setting Range	0.5 ~ 400 HZ
USA Version	120 HZ
European Version	50 HZ

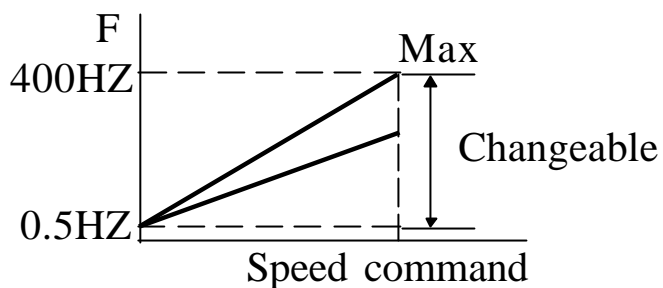

Minimum frequency limit
CD15

Setting Range	0 ~ 400 HZ
Factory Setting	0

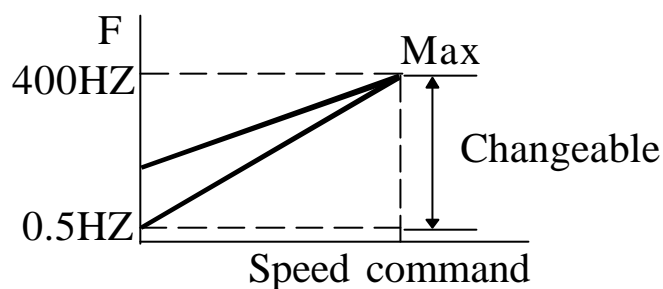

Frequency display scale
CD16

Setting Range	0.5 ~ 400 HZ
USA Version	1 HZ
European Version	30 HZ

Use the following equation to calculate the mechanical shaft speed in rpm.

$$\text{RPM} = \text{HZ} \times \text{Scale setting}$$

When $\text{RPM} > 9999$ display

-	-	E	-
---	---	---	---

 for over range warning.

Setting CD41=1 for display shown RPM.

Pole	Synchronous speed		Scale setting
	50HZ	60HZ	
2	3000	3600	60
4	1500	1800	30
6	1000	1200	20
8	750	900	15
10	600	720	12
12	500	600	10

Maximum voltage frequency
CD17

Setting Range	25 ~ 400 HZ
USA Version	60 HZ
European Version	50 HZ

For constant torque and constant power setting.

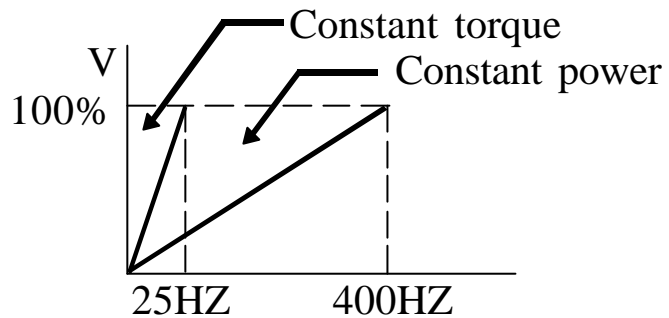

V/F pattern
CD18

Setting Range	0 ~ 2
Factory Setting	0

- 0 = Constant torque curve
- 1 = Reduce torque curve $F^{2.0}$
- 2 = Reduce torque curve $F^{3.0}$

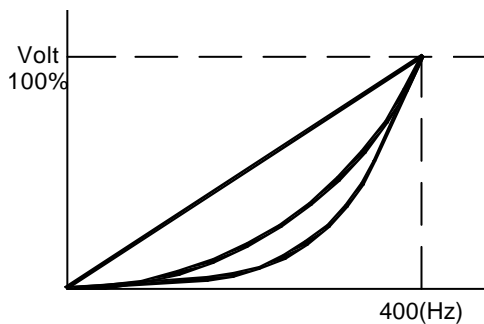

DC braking time
CD19

Setting Range	0 ~ 25 Sec
Factory Setting	1 Sec

DC brake starting at frequency under 0.5HZ.

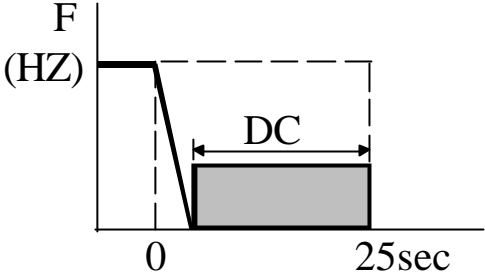

DC braking power
CD20

Setting Range	0 ~ 250
Factory Setting	10

CD20 setting DC voltage gain various braking power.

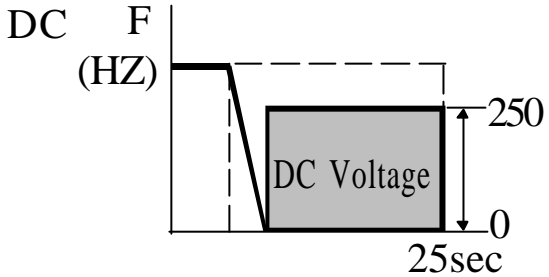

Torque boost
CD21

Setting Range	0 ~ 25 %
Factory Setting	0 %

Torque boosting is used to compensate the torque lost due to stator resistance. Over boosting will cause over current and high acoustic noise.

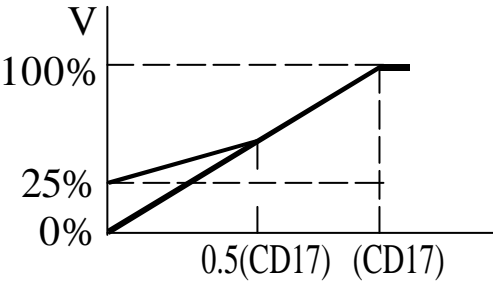

Second speed setting
CD22

Setting Range	0 ~ 400 HZ
Factory Setting	20 (B03) / 0 (B04)

Third speed setting
CD23

Setting Range	0 ~ 400 HZ
Factory Setting	30 (B03) / 0 (B04)

Fourth speed setting
CD24

Setting Range	0 ~ 400 HZ
Factory Setting	40 (B03) / 0 (B04)

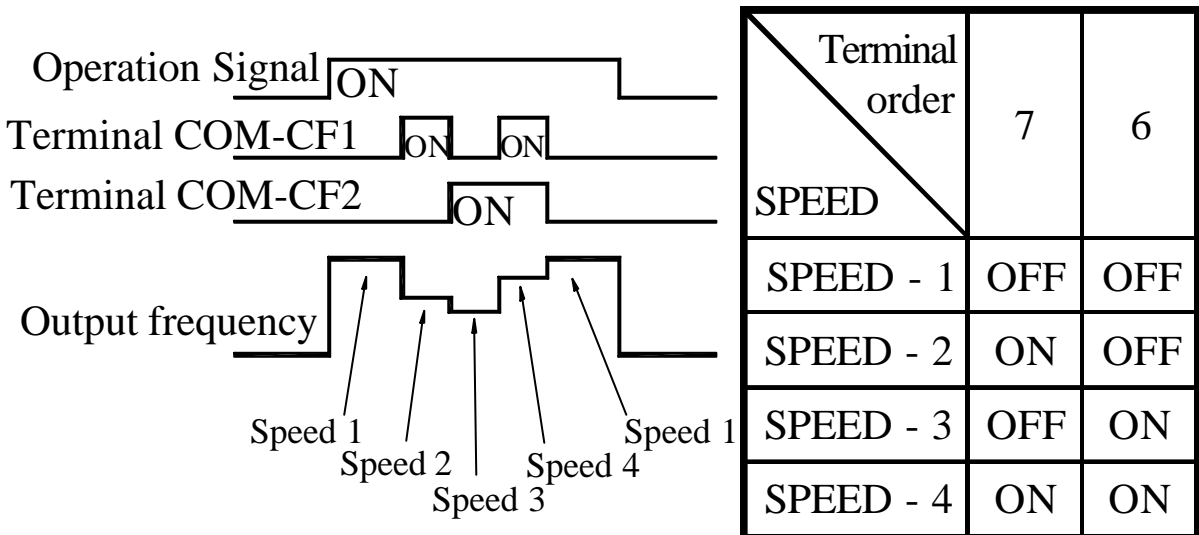

Acceleration time 2
CD25

Setting Range	0.1 ~ 6000 SEC
Factory Setting	10 SEC

Deceleration time 2
CD26

Setting Range	0.1 ~ 6000 SEC
Factory Setting	10 SEC

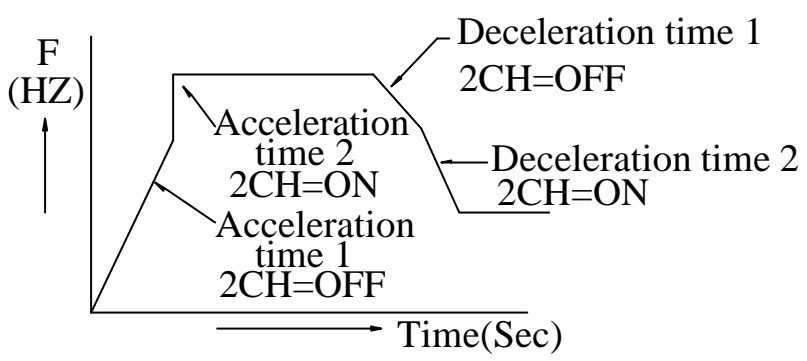

Description	2CH
Acceleration time 1	OFF
Deceleration time 1	
Acceleration time 2	ON
Deceleration time 2	

To operate inverter with 2CH function, check to see CD42 or CD43=3. 2CH command inputs from FT1 or FT2 terminal.

Carrier frequency
CD27

Setting Range	1 ~ 16 K
Factory Setting	16 K

Increase the carrier frequency would reduce motor acoustic noise but efficiency might be decreased.

Reduce the carrier frequency would reduce RF1 noise, reduce motor current, and then gain better efficiency.

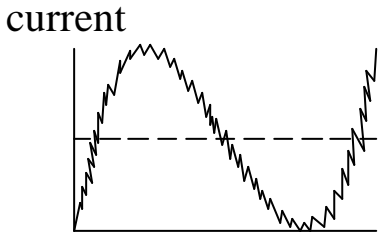

Low carrier frequency

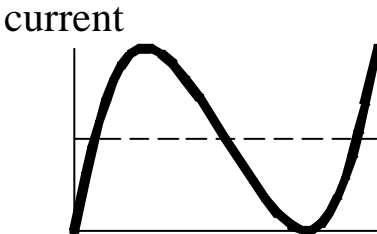

High carrier frequency

Output voltage gain
CD28

Setting Range	50 ~ 100 %
Factory Setting	100 %

Reduce output voltage for energy saving operation.
 Setting CD44(45)=12 for FA1 (FA2) terminal control.

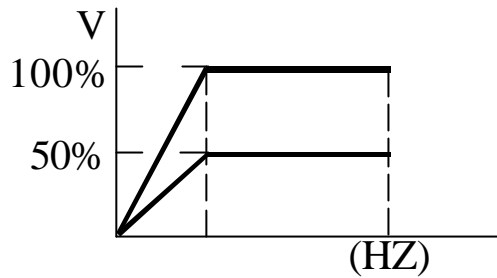

Frequency jump 1
CD29

Setting Range	0 ~ 400 HZ
Factory Setting	0 HZ

Frequency jump 2
CD30

Setting Range	0 ~ 400 HZ
Factory Setting	0 HZ

Frequency jump 3
CD31

Setting Range	0 ~ 400 HZ
Factory Setting	0 HZ

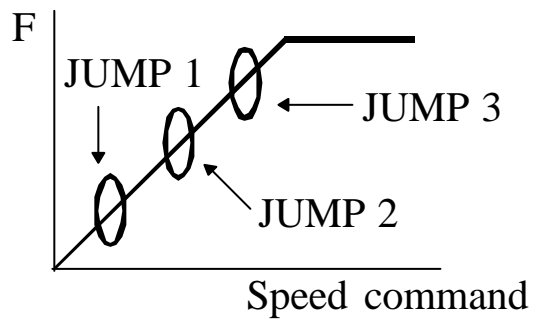

Jump range
CD32

Setting Range	0.5 ~ 3 HZ
Factory Setting	0.5 HZ

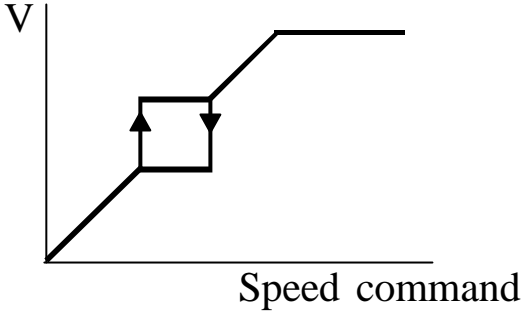

Frequency reference bias
CD33

Setting Range	0 ~ 400 HZ
Factory Setting	0

Move Frequency bias with same gradient.
 Frequency at negative bias range, The motor can not start.

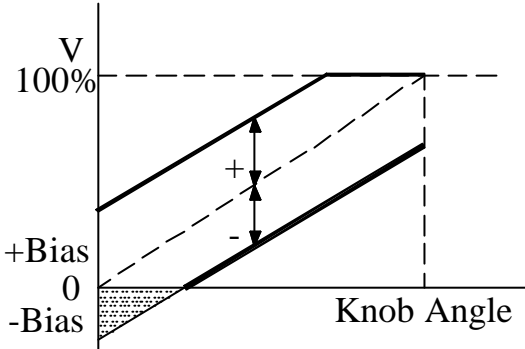

Freq. ref. bias direction
CD34

Setting Range	0 or 1
Factory Setting	0

0 = Positive “+ “
 1 = Negative “-“
 Polarity setting for (CD33) frequency reference bias.

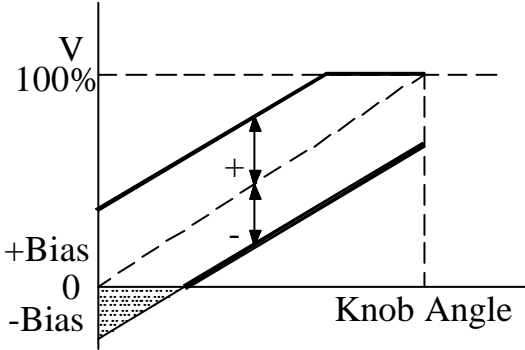

Frequency gain
CD35

Setting Range	40 ~ 200 %
Factory Setting	100 %

Application refer to example 04 at page 52.

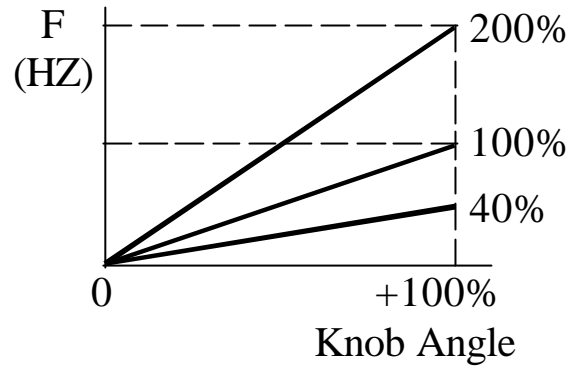

The latest error record
CD36

Error record 1
CD37

Error record 2
CD38

Error record 3
CD39

Errors record flow-chart when Error occur. The new content will shift the other contents to one higher CD code and the highest one will be dropped.

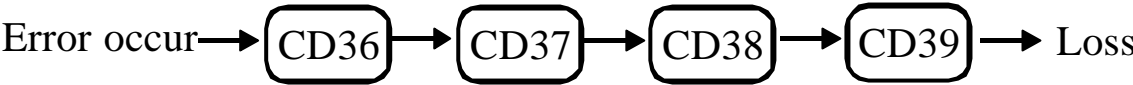

Clear errors record
CD40

Setting Range	0 or 1
Factory Setting	0

Set CD40=1 and **PROG** clear CD36 ~ CD39 Error Record the contents in CD36 ~ CD39 are “ NONE “

HZ/RPM Display
CD41

Setting Range	0 or 1
Factory Setting	0

0 = HZ Display 1 = RPM Display
 Setting current scale CD16 for rpm display shown.

FT1 Multi-Function Terminal 1
CD42

Setting Range	0 ~ 15
Factory Setting	0

FT1 FT2	Symbol	Function description
0	-----	-----
1	JOGF	Jog operation FWD command
2	JOGR	Jog operation REV command
3	2CH	ACC/DEC time 2 command
4	FRS	Free running command
5	3 - WIRE	3 - wire sequence mode
6	CF3	5 - 8 Speed Setting Terminal
7	VF2	2nd V/F curve setting (CD56)
8		Reserved
9	OH	External over temperature command
15		Reserved

3 - WIRE CIRCUIT CONNECTION DIAGRAM (terminal latch function)

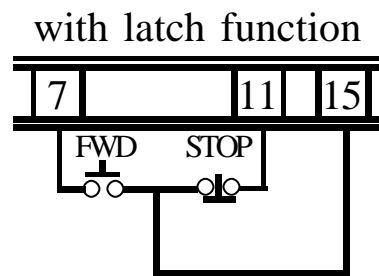
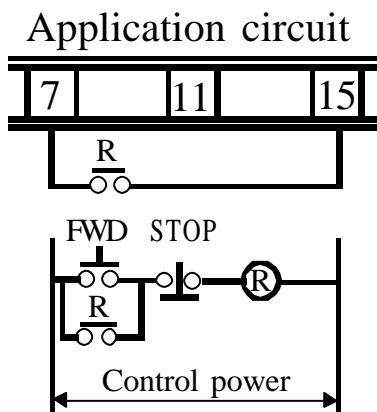
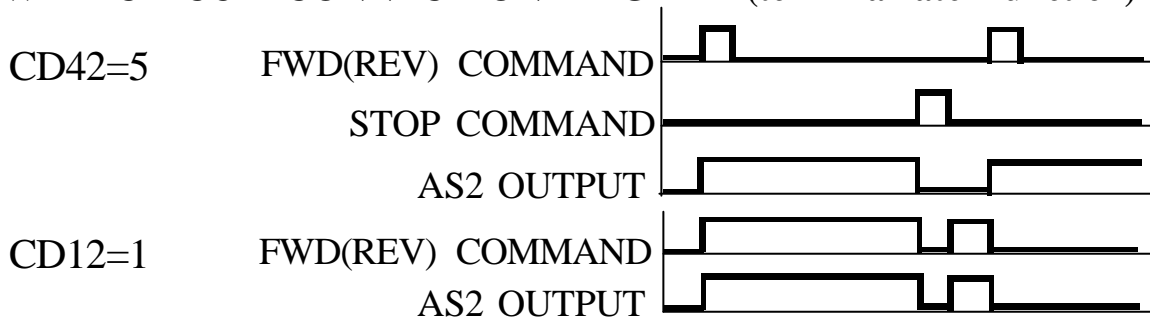

Ⓜ and CONTROL POWER not necessary
 Remark: STOP command entry from control terminal ⑪ FT1 or ⑫ FT2, and set CD42(FT1)=5 or CD43(FT2)=5 before operation.

FT2 Multi-Function Terminal 2
CD43

Setting Range	0 ~ 15
Factory Setting	0

Refer to CD42 table.

Used for connection refer to 3-2 jumper setup (page 11).

Free analog terminal 1
CD44

Setting Range	0 ~ 15
Factory Setting	0

Refer to CD45 table.

Free analog terminal 2
CD45

Setting Range	0 ~ 15
Factory Setting	0

Setting NO. 11 to use application of example 04 (page 52).

FA1 FA2	Function	Setting Range Min-----Max
0	-----	-----
1	Acceleration time 1	0 ~ CD02 Content
2	Deceleration time 1	0 ~ CD03 Content
3	Acceleration time 2	0 ~ CD25 Content
4	Deceleration time 2	0 ~ CD26 Content
5	Boost setting	0.0 ~ 25.0 %
6	DC Brake time	0 ~ 25 Sec
7	DC Brake Energy	0 ~ 250
8	Speed 2	F-min ~ F-max
9	Speed 3	F-min ~ F-max
10	Speed 4	F-min ~ F-max
11	Fmax	F-min ~ CD14 content
12	Output voltage gain	50% ~ 100%
13	Speed 1	F-min ~ F-max
14	Reserved	
15	Reserved	

5th speed setting
CD47

6th speed setting
CD48

7th speed setting
CD49

8th speed setting
CD50

Dynamic braking energy limit
CD51

SPEED	CF3	CF2	CF1
1th speed setting	OFF	OFF	OFF
2th speed setting	OFF	OFF	ON
3th speed setting	OFF	ON	OFF
4th speed setting	OFF	ON	ON
5th speed setting	ON	OFF	OFF
6th speed setting	ON	OFF	ON
7th speed setting	ON	ON	OFF
8th speed setting	ON	ON	ON

For example, set 8th speed as follows :

1. CD12=1 (Terminal function)
2. CD42 or CD43=6 (Function command)
(FT1 or FT2 → CF3)

The higher the percentage, the more braking energy.

The lower the percentage, the lower braking energy.

Description of regenerative discharge braking active period.

1. 0 ~ 100% Decel only
2. 101 ~ 200% Braking active period of
(Decel/accel/constant frequency)
3. 201 ~ 300% Braking active period of
(Decel/accel/constant frequency/stand-by)

Version selector
CD52

Eur → European Version
USA → US Version

Select function CD52, then use UP/Down key to select Eur/USA Version. Press **PROG** to save it. System return to the factory setting.

S curve
CD53

Setting Range	0 ~ 7
Factory Setting	0

Setting S curve non-Linear Accel/Decel Operation from 1 to 7. Setting 0 is normal operation without S curve.

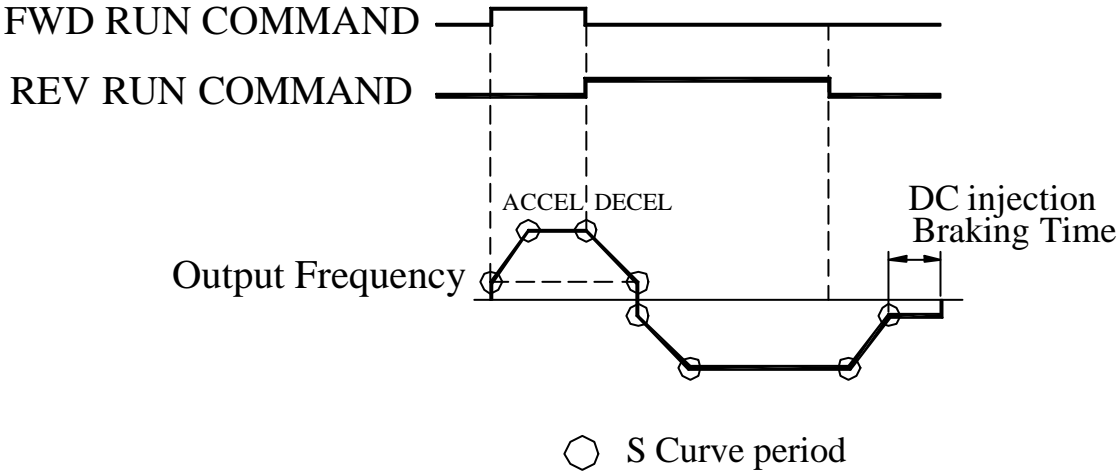
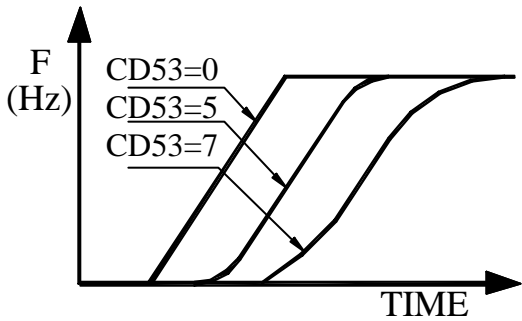

4 ~ 20 mA
CD54

Setting Range	0 ~ 3
Factory Setting	0

Set FA1 (FA2) for current signal (4 ~ 20mA). This function only effects in CD44(CD45)=8,9,10,13

- 0 : NO Current Signal Application
- 1 : Current Signal in Terminal FA1
- 2 : Current Signal in Terminal FA2
- 3 : FA1 & FA2 Current Signal Terminal

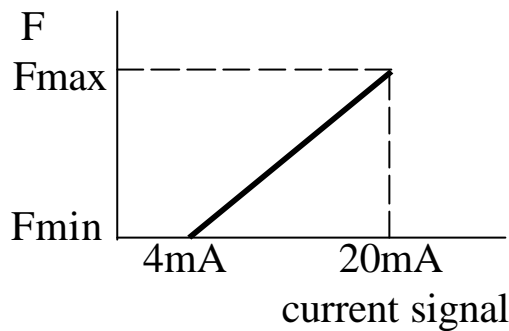

Frequency arrive signal range
CD55



Setting Range	0% ~ 100%
Factory Setting	10%

JP1 selector moves to ARR connection. If running Freq is suitable the attachment lists, the MT terminal will output ON signal.

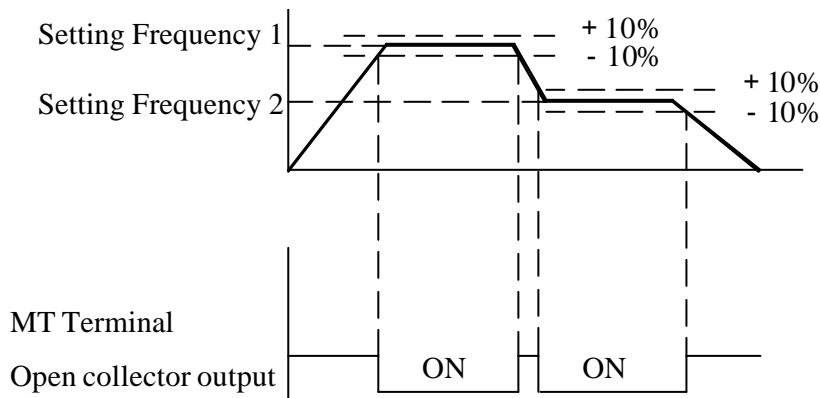
- 1.Signal output at running F. setting $F \times (1 - CD55\%)$ for acceleration.
- 2.Signal output at running F. setting $F \times (1 + CD55\%)$ for deceleration.



Note : When setting CD55, please follow the sequence.

1. set CD15 = 0
2. set CD55 = xx use   or  key (xx cd value)
3. set CD15 = xx (if xx > 0)

2nd Maximum Voltage frequency
CD56

Setting Range	25 ~ 400
Factory Setting	120

Set CD42(CD43)=7 define FT1(FT2) Terminal for hardware V/F curve switcher.

Open : select the 1st V/F curve preset in CD17

Close : select the 2nd V/F curve preset in CD56

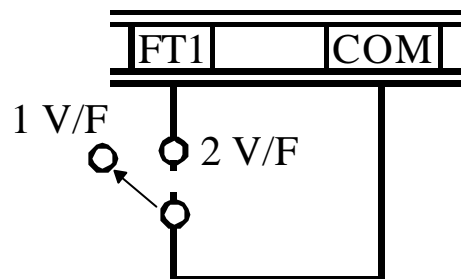
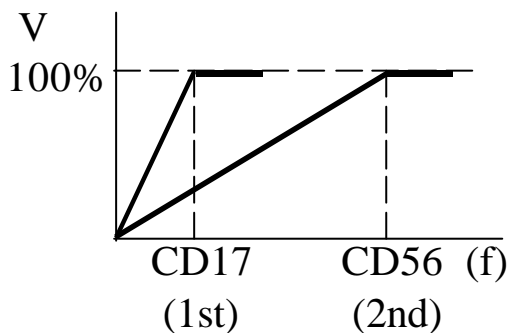

No. of auto restart attempt
CD57

Setting Range	0 ~ 10
Factory Setting	0























Inverter auto restart if power device failure Max. auto restart times are 10 within 30 min.

7-2. Operation key-in sequence

EXAMPLE : CHANGE acceleration time

Setting sequence	Display indicator	Description
		In waiting mode, the display is blinking
		Enter function mode
		Select function number 1 (parameter lock)
		Press "FUNC" again to change the parameter value
		Enable to change parameter
		Save the parameter and back to waiting mode
		Enter function mode
		Select function number 2 (acceleration time)
		Press "FUNC" again to change the parameter value
		Select the first digit
		Increase the value to 3
		Select the second digit
		Increase the value to 2
		Save CD02=12.3 and back to waiting mode

CHANGE maximum frequency limit

Setting sequence	Display indicator	Description
		Enter function mode
 		Increase the value to 4
 		Select the second digit
		Increase the value to 1
		Press "FUNC" again to change the Maximum frequency limit
  		Select the second digit
  		Decrease the value to 9
		Save CD14=90HZ and back to waiting mode

8. DISPLAY ERROR CODES

A. Inverter self-checking errors

Internal protection
CPU

Noise protection.

Self test failure protection

Program check sum error
EP0

EEPROM access error
EEP1

EEPROM check-sum error
EEP2

Power device failure 1
PF01

Power device failure during acceleration

Power device failure 2
PF02

Power device failure during constant frequency

Power device failure 3
PF03

Power device failure during deceleration (stopping)

Power device failure 4
PF04

Power device failure during stand-by

B. Operation errors

Parameter Locked
OPE1

To change the contents of CD02~CD52 set CD01=press  first

FWD or REV only
OPE2

Motor direction limiter.
See function description 6.1:CD08

Analog signal input only
OPE3

Motor speed command from control terminal only.
Input analog signal by Frequency knob
see functions description 6.1:CD10

Terminal command only
OPE4

Accept run command from control terminal only.
Not operation panel.
See functions description 6.1:CD12

Over range error
OPE5

Operating error message ~ over range.

Logic error warning
OPE6

Logic error when setting.
EXAMPLE : Setting F-min > F-max will result an error.

Only changed in standby
OPE7

The parameter can only be changed in standby mode.

Read only parameter
OPE8

The parameter created by system. Unable to be changed by user.

9. HARDWARE PROTECTIVE FUNCTION

- (1) Over-current protection**
- (2) Short circuit protection**
- (3) Over-temperature protection**
 - A. U V W phase short protection**
 - B. Ground short protection**
- (4) Control supply under-voltage protection**
- (5) Power source under voltage**
- (6) Over voltage protection**

10. PRECAUTIONS

10-1 Prior to maintenance, check the following :

- (1) Before maintenance, be sure to turn the power off and wait until the LED digits vanish in the display. However, approx. 50 VDC still remains immediately after the display disappears, so wait a little bit longer.**
- (2) When removing or re-installing a connector, do not pull the cable.**
- (3) Take special care not to misplace the connector. Carefully note any disconnecting or poor contact. Be sure to tighten the terminals and connectors securely.**

10-2 Application precautions

- (1) Before you start operation, thoroughly check for erroneous wiring or short circuits in the motor or in the wiring between your motor and the inverter. Do not ground the neutral point of the motor with a star connection.**
- (2) An inverter-driven run generates a certain amount of electromagnetic noise, as compared with that of driven directly by a commercial power supply. Thus you should be aware of such limitation when using an inverter-driven motor at a noise-sensitive site.**
- (3) Before setting the maximum frequency at 60HZ or higher, confirm that this operation range is acceptable with that of your motor.**
- (4) When you determine an appropriate inverter capacity, ensure that the rated current of the motor does not exceed the inverter' s rated current.**
- (5) Install a mold-case circuit breaker (MCCB) at the inverter' s power supply end to protect the wiring.**

11. TROUBLESHOOTING

Display symbol	Cause of fault message contents	Check point	Suggested remedy
No display	Discharge LED extinguished	Review the power system. Check that MCCB has been turned on or no poor contact.	Turned on or Replace MCCB
PF01	Power device failure during acceleration	The acceleration time is too short.	Increase the acceleration time
		Boost voltage too high	Reduce CD21 contents
		Check the motor is locked or the load is too heavy	Reduce the load factor
PF02	Power device failure during constant frequency operation	Check for sudden change in load	Eliminate sudden change in load
		Check that the ambient temperature is too high	Reduce the ambient temperature
		Power supply voltage is too high.	Reduce the voltage within specified range
PF03	Power device failure during deceleration	The load GD^2 is excessive	Set the deceleration time suitable for load GD^2
		Power supply voltage is too high	Reduce th voltage within specified range
PF04	Power device failure during stand-by	Check around the noise source. Power supply voltage is too high.	Remove the cause Reduce the voltage
EEP1	EEPROM access error	Rework with previous process. Check for the same message.	Repair
EEP2	EEPROM check-sum error		

12. APPLICATION

EXAMPLE 01 : Using variable resistor for multistage speed setting

DESCRIPTION :

- CD10 = 1 (Use frequency knob for 1st speed setting)
- CD12 = 1 (External command)
- CD44 = 8 (2nd speed signal enter from FA1)
- SW1 = RUN / STOP
- SW2 = 1st / 2nd SPEED

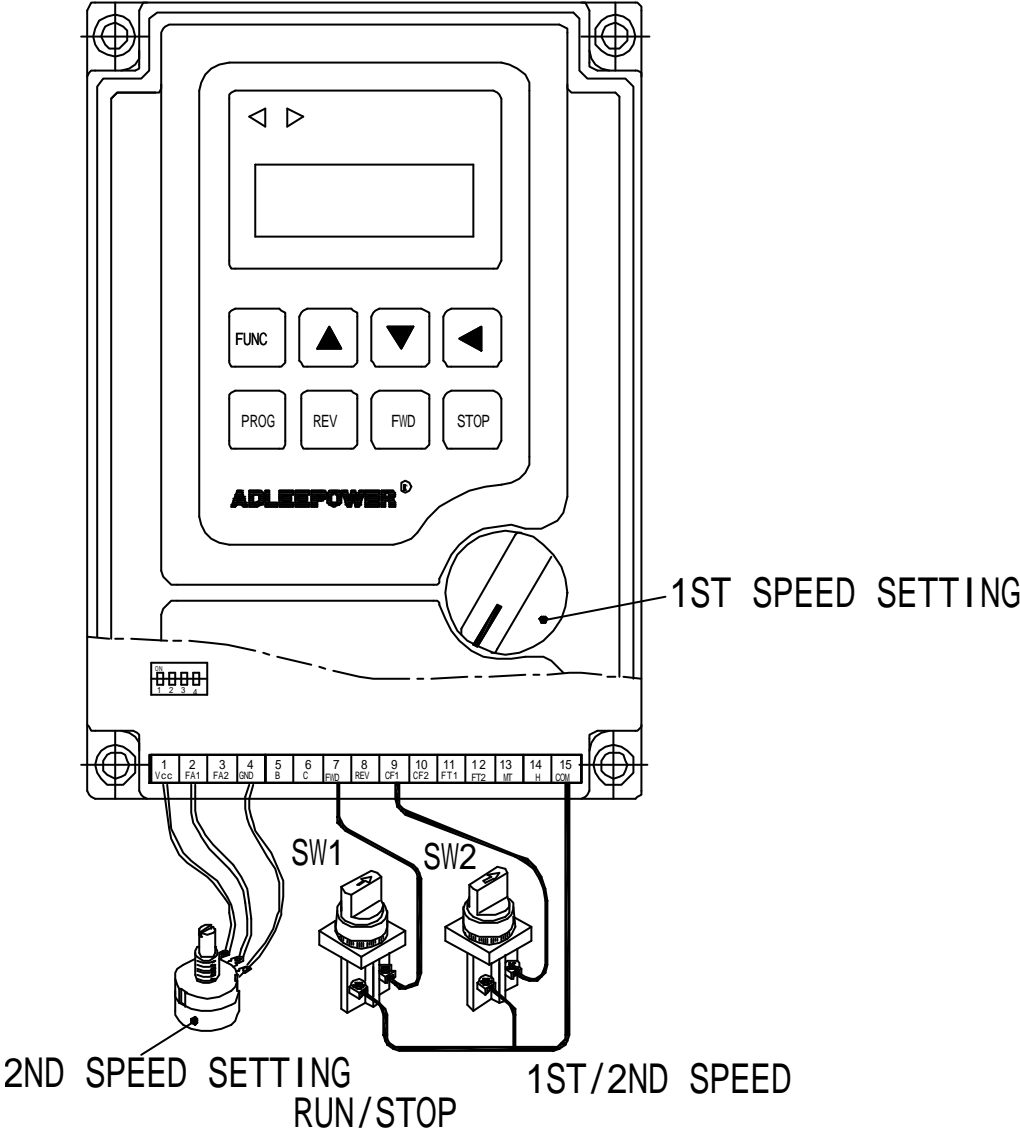

EXAMPLE 02 : Normal / Jog operation

DESCRIPTION :

- CD00 = Normal speed ; User setting
- CD04 = Jog speed ; User setting
- CD12 = 1 ; Terminal command (For External)
- CD42 = 1 ; Define FT1 Terminal = JOGF function
- CD43 = 2 ; Define FT2 Terminal = JOGR function

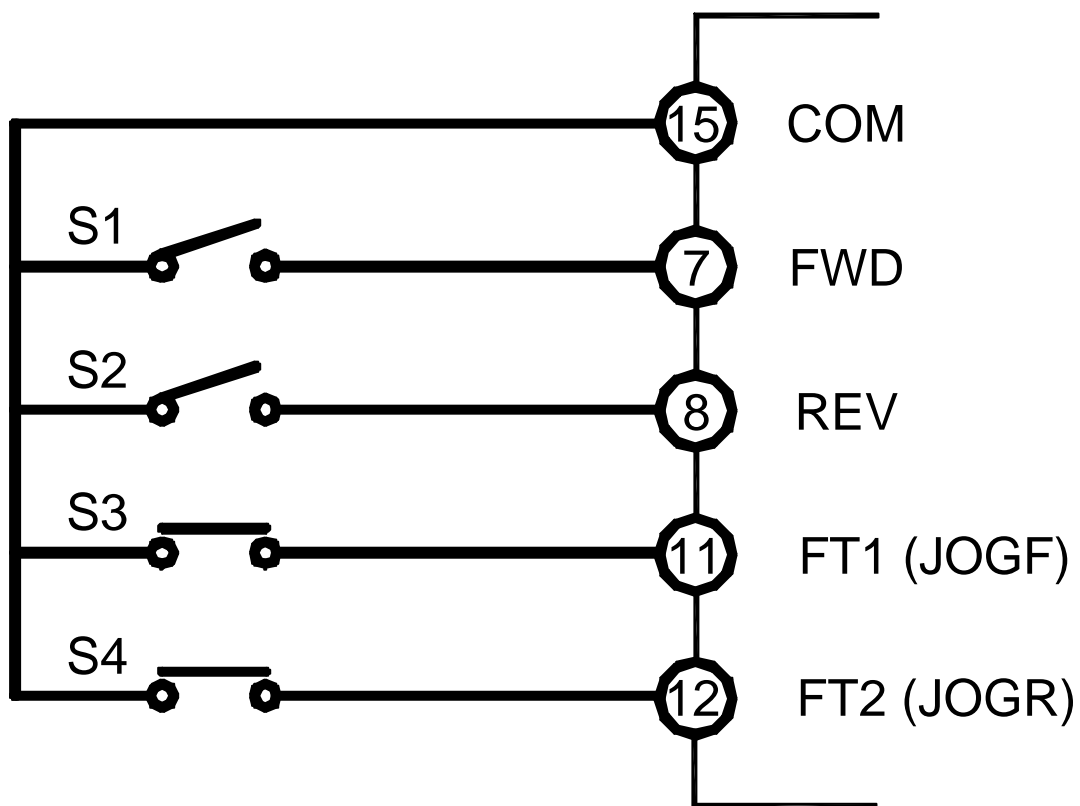

NORMAL / JOG

- S1 = FWD SW
- S2 = REV SW
- S3 = FWD JOG SW
- S4 = REV JOG SW

EXAMPLE 03 : Using rheostart for 3stage speed setting

DESCRIPTION :

- CD12 = 1 ; Terminal command (For External)**
- CD44 = 8 ; 2nd speed signal enter from FA1**
- CD04 = 1 ; 3nd speed signal enter from FA2**

SPEED	TERMINAL		SPEED COMMAND ENTRY
	SW2	SW1	
1	OFF	OFF	FREQUENCY KNOB
2	OFF	ON	VR2
3	ON	OFF	VR3

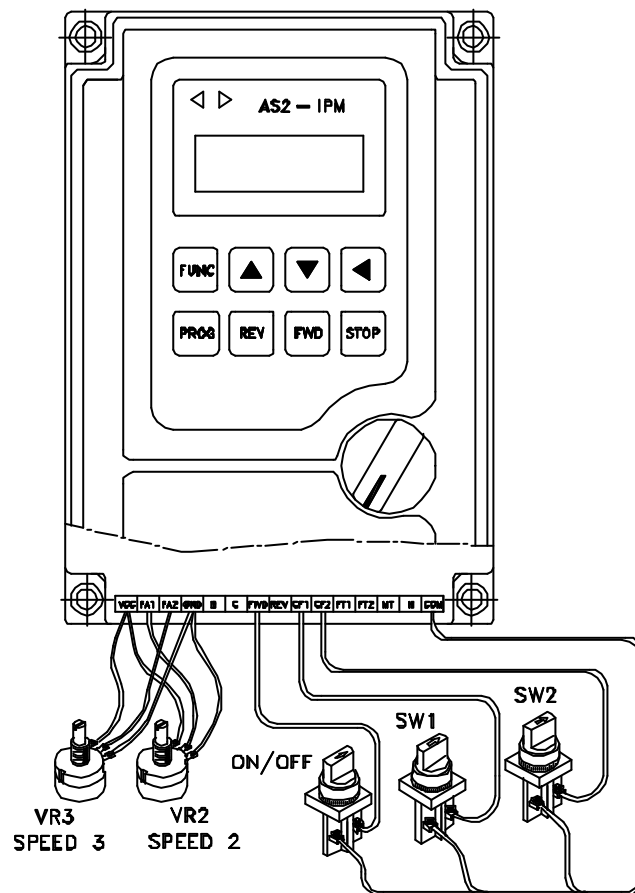

EXAMPLE 04 : Master / slave driver system

DESCRIPTION : Set FA1 as 2nd speed signal input terminal.

Connect COM and CF1 for 2nd speed command always.

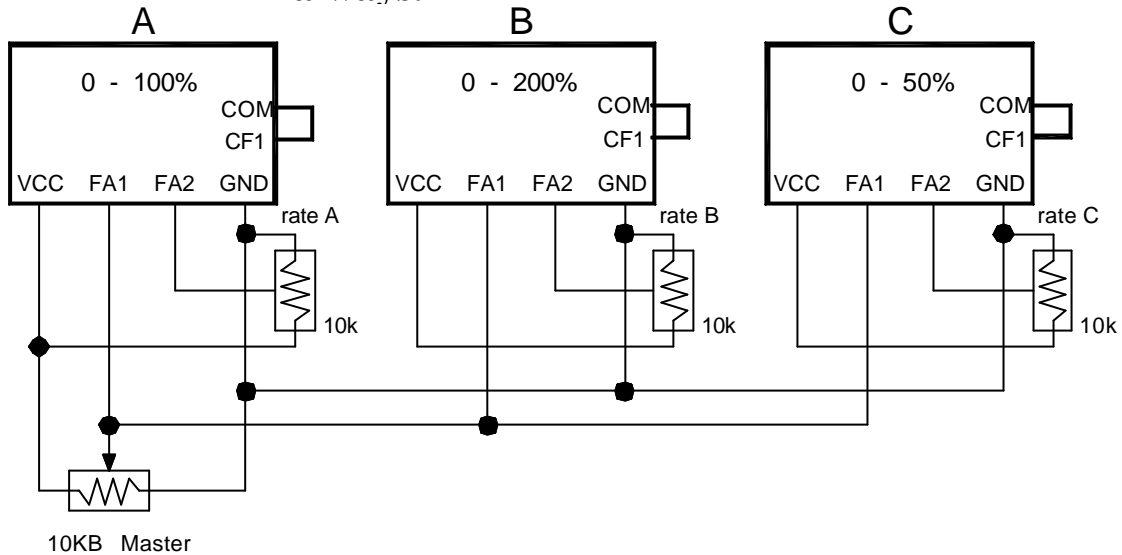

Number	A	B	C
Speed rate	0 ~ 100%	0 ~ 200%	0 ~ 50%
Function setting	CD12 = 1 CD14 = 100 CD44 = 13 CD45 = 11	CD12 = 1 CD14 = 200 CD44 = 13 CD45 = 11	CD12 = 1 CD14 = 50 CD44 = 13 CD45 = 11

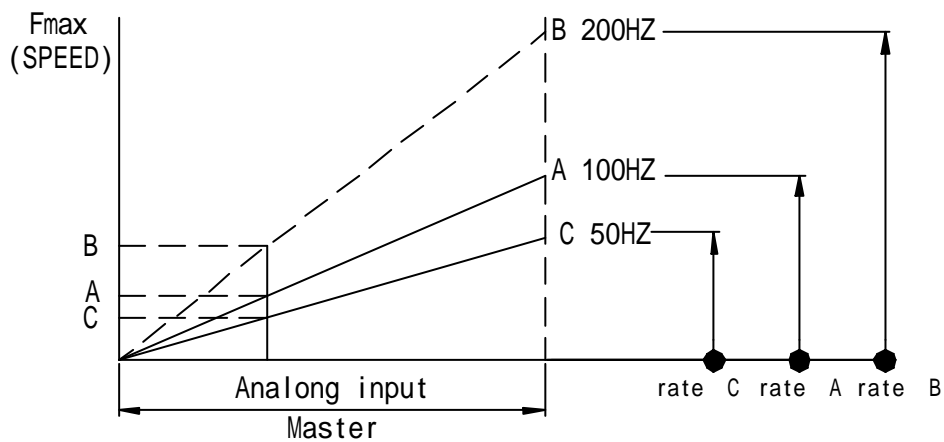

13. Inverter Selection

Inverter Capacity Check Method

Description		Related factor
Load characteristics	Load type	Friction load and weight load Liquid(viscous) load inerita load Load with power transmission and accumulation
	Load speed and torque characteristics	Constant torque Constant power Decreasing torque
	Load characteristics	Motoring Braking or overhanging load Constant load Shock load Repetitive load High-start torque Low-start torque
Operastion	Continuous operation Long-time operation at medium or low speeds Short-time operation	
Rated output	Maximum required output(instantaneous) Constant output(continuous)	
Rated rpm	Maximum rpm Rated rpm	
Power supply	Power supply transformer capacity and percentage impednace Voltage fluctuations Number of phases, less phase protection Frequency	
Deterioration of load capacity due to age	Mechanical friction, losses in wiring	
	Duty cycle modification	

Speed and Torque Characteristics	Time Ratings	Overload Capacity	Starting torque

14. APPENDIX

A. Optional braking resistor

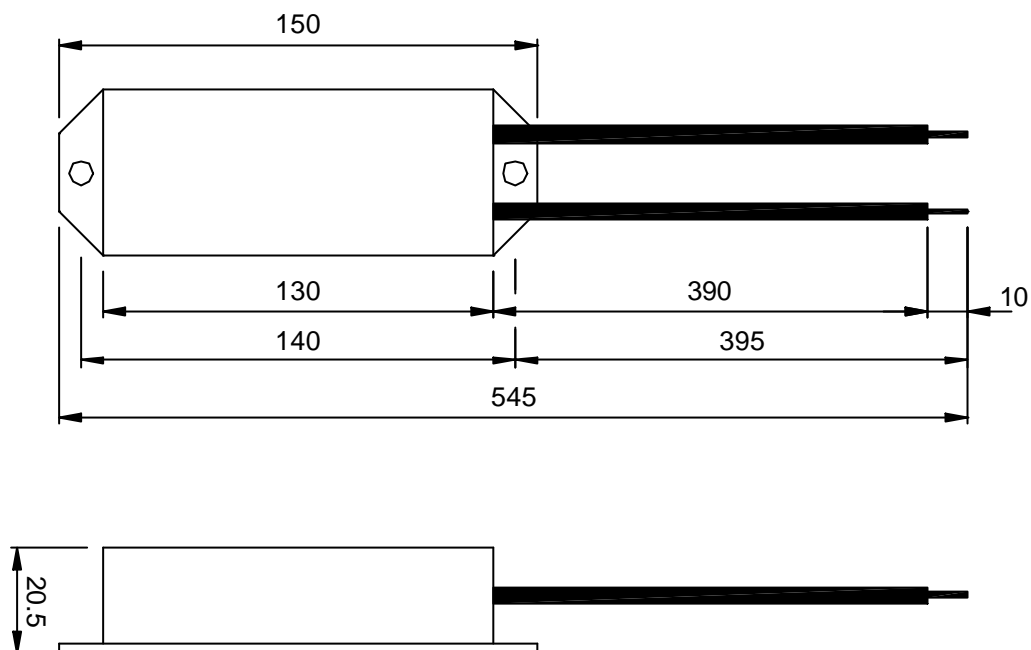

- A. The resistance of braking resistor is recommended in below list.
 The resistance must be larger than that shown in list.
 If not, may be damaged the inverter, when one want to add external braking resistor, it must remove the P,PR wiring first.
- B. Increase dynamic resistor capacity(W) when Deceleration time is setting short, or braking operation frequently.

Unit : Ohm

Model No	(3)04	(3)07	(3)15	(3)22	(3)37
AS1	60	60	--	--	--
AS2	60	60	60	60	40
AS4	200	180	180	180	160

B. Terminals wiring diagram

1. SINGLE PHASE

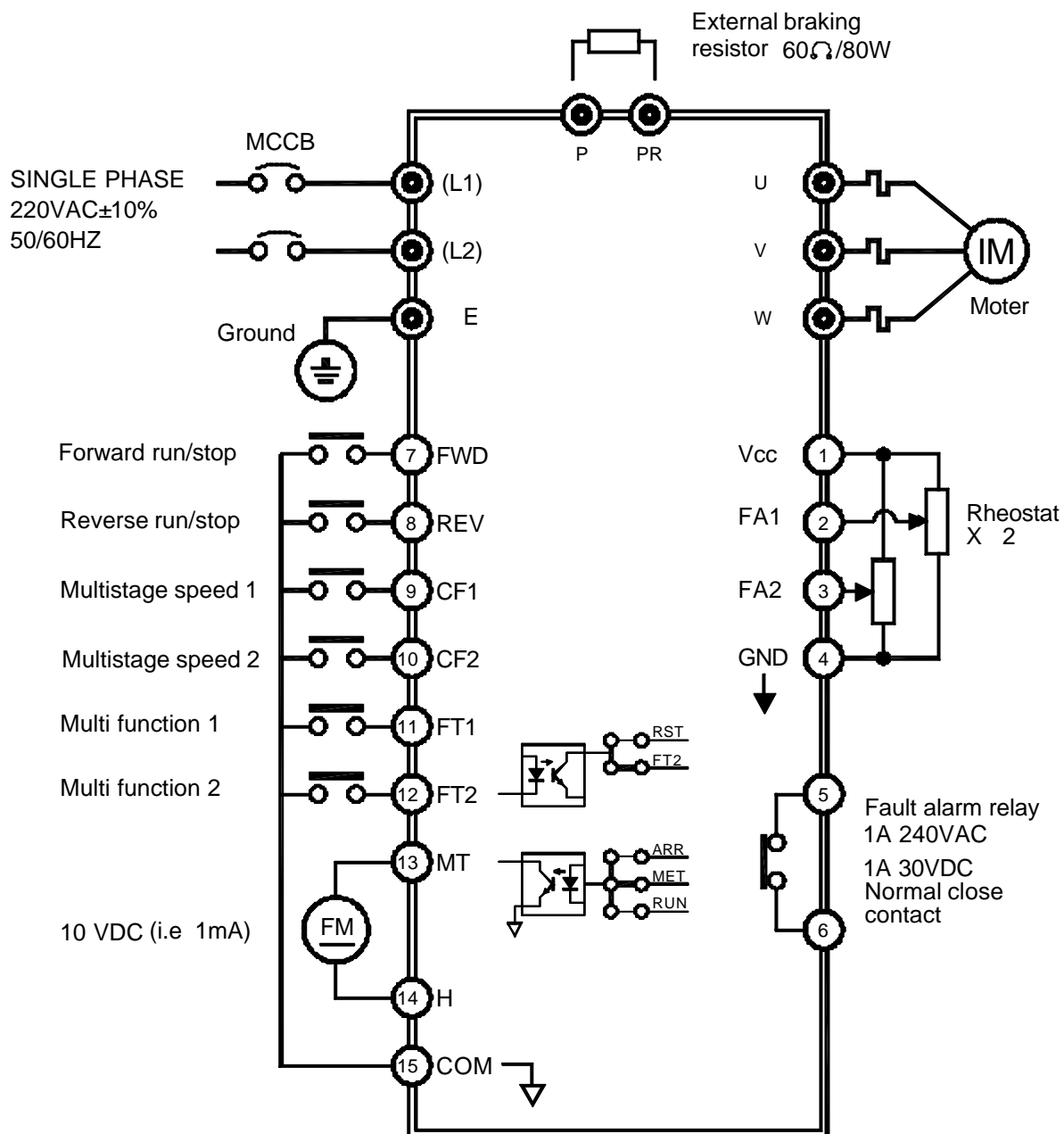

2. THREE PHASE

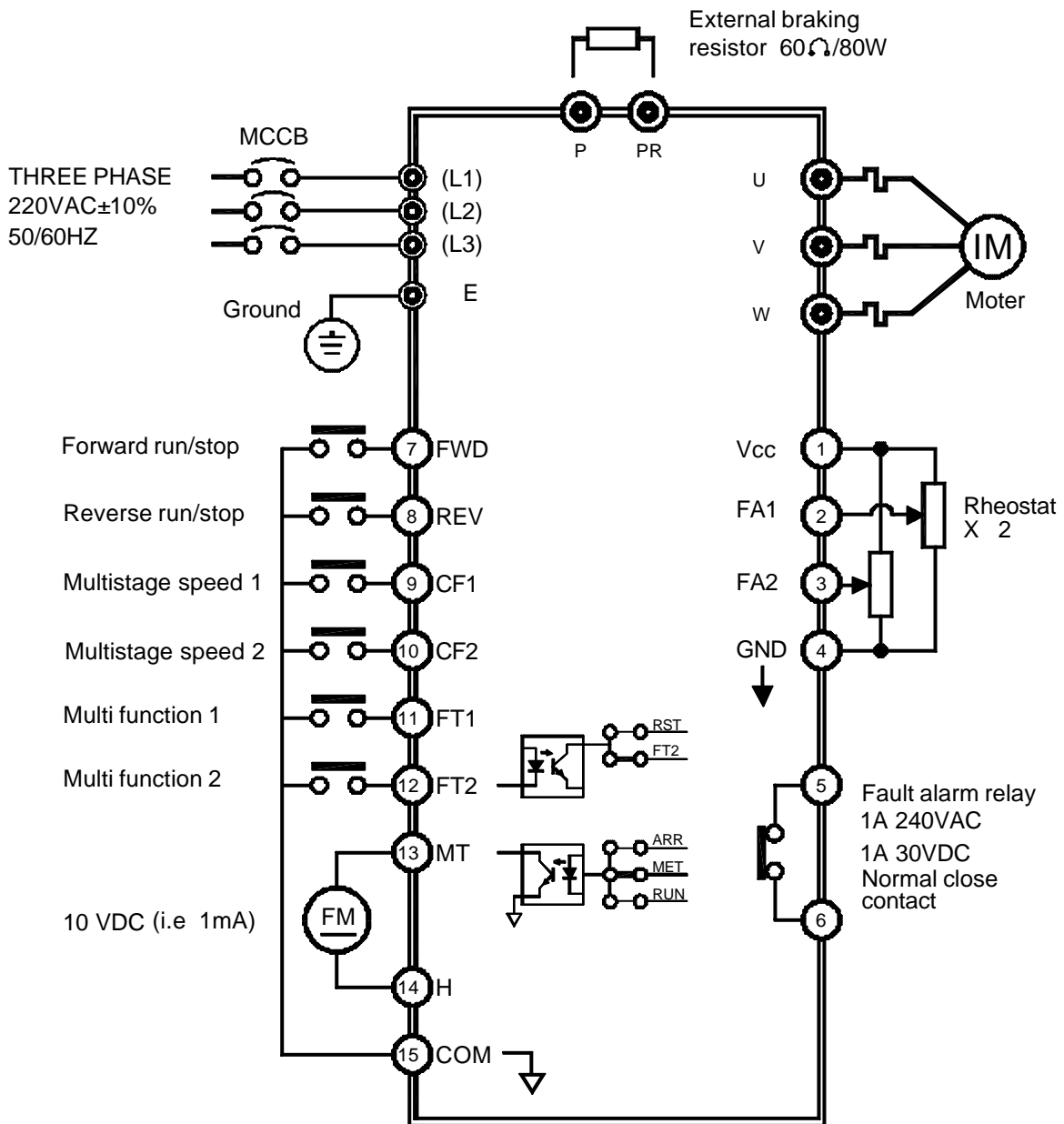

C. F300 Remote operator

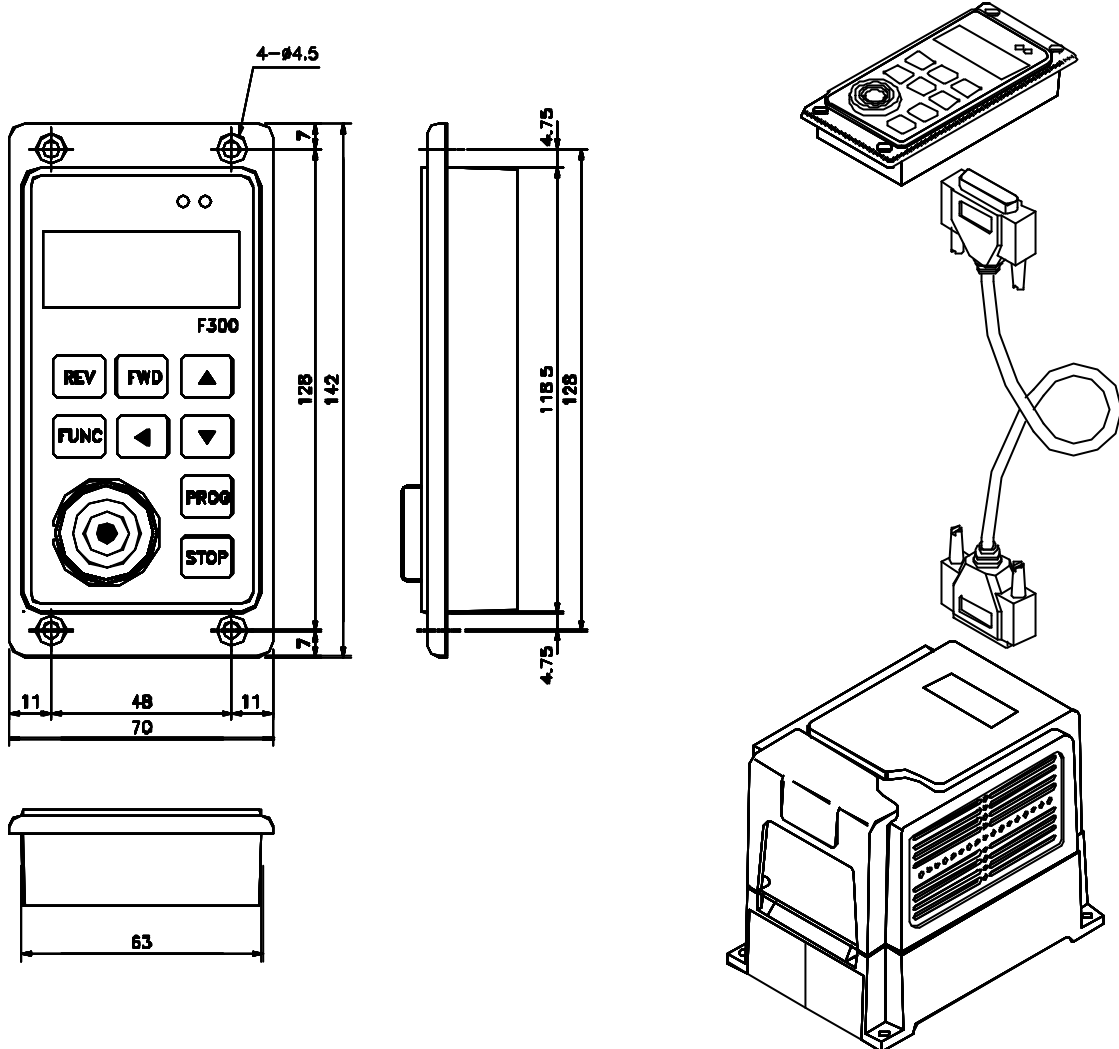

UNIT : M/M

F300 remote operator are for the remote inverters.
 Please order “R“ model inverters for remote control
 as AS2-(3)04R, AS2-(3)07R, AS2-(3)15R,
 AS2-3(22)R and mark the extension cord length.
 (1M/3M/5M)

D. Version

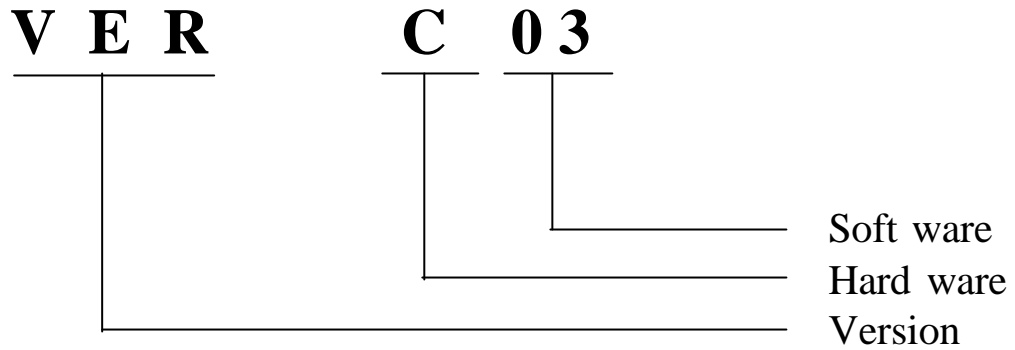

HARDWARE	DATE	NEW FUNCTIONS
Cxx	99.02	

SOFTWARE	DATE	NEW FUNCTIONS

MEMO

MEMO

MEMO

MEMO

MEMO

MEMO

INSTRUCTION MANUAL

PART NO : E-PHAA-EASB03

Model : AS series

Printed in Taiwan 2004 API. 8th Edition



愛德利 科技股份有限公司

ADLEE POWERTRONIC CO., LTD.

Taiwan Head Office

Tel No : 886-4-25622651

Fax No : 886-4-25628289

E-mail : webmaster@adlee.com

URL : <http://www.adlee.com>

Canada Office

Tel No : 1-604-3246578

E-mail : amerigo@adlee.com

China Hong Kong Office

Tel No : 852-24081937

E-mail : hongkongo@adlee.com

China Shanghai Office

Tel No : 86-21-64843529

E-mail : shanghaigo@adlee.com

China Guang Dong Office

Tel No : 86-757-26656498

E-mail : guandongo@adlee.com

China Wu Han Office

Tel No : 86-27-85712401

E-mail : wuhango@adlee.com